

# Operating Instructions

**TransPocket 150 TIG**  
**TransPocket 180 TIG**

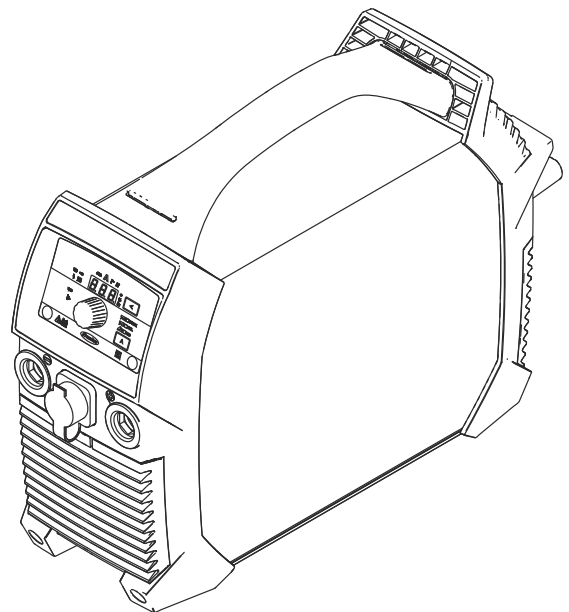

**EN** | Operating Instructions





# Contents

Safety rules.....	5
Explanation of safety notices .....	5
General.....	5
Proper use .....	6
Environmental conditions.....	6
Obligations of the operator.....	6
Obligations of personnel.....	6
Mains connection.....	7
Residual current protective device.....	7
Protecting yourself and others.....	7
Noise emission values .....	8
Danger from toxic gases and vapours.....	8
Danger from flying sparks .....	9
Risks from mains current and welding current.....	9
Meandering welding currents .....	10
EMC Device Classifications.....	10
EMC measures.....	11
EMF measures.....	11
Specific hazards.....	11
Requirement for the shielding gas.....	12
Danger from shielding gas cylinders.....	13
Safety measures at the installation location and during transport.....	13
Safety measures in normal operation.....	14
Commissioning, maintenance and repair.....	14
Safety inspection.....	15
Disposal.....	15
Safety symbols.....	15
Data protection .....	15
Copyright.....	16
General.....	17
Device concept.....	17
Warning notices on the device.....	17
Application areas.....	18
Before commissioning.....	20
Safety .....	20
Proper use .....	20
Setup regulations.....	20
Generator-powered operation.....	21
Controls, connections and mechanical components.....	22
Safety .....	22
TransPocket 150 controls, connections and mechanical components.....	23
TransPocket 180 controls, connections and mechanical components.....	24
Control panel.....	25
MMA welding .....	27
Preparation.....	27
MMA welding .....	28
SoftStart / HotStart function .....	28
Arc-force dynamic.....	29
Pulse welding.....	30
TIG modes.....	32
Symbols and their explanations.....	32
2-step mode.....	32
4-step mode.....	33
TIG welding.....	34
General.....	34
Connecting the gas cylinder .....	34
Preparation.....	35
Setting the gas pressure .....	36
TIG welding.....	36
TIG Comfort Stop.....	37

Pulse welding.....	38
Tacking function.....	39
Welding process Setup menu.....	41
Accessing the Setup menu.....	41
Changing welding parameters.....	41
Exiting the Setup menu.....	41
Parameters for MMA welding.....	41
Parameters for TIG welding.....	43
Setup menu - Level 2.....	45
Welding parameters in the level 2 Setup menu.....	45
Care, maintenance and disposal.....	47
Safety.....	47
General.....	47
Maintenance at every start-up.....	47
Maintenance every 2 months.....	48
Disposal.....	48
Troubleshooting.....	49
Safety.....	49
Indicated errors.....	49
Service messages.....	49
No function.....	51
Faulty operation.....	52
Average consumption values during welding.....	54
Average wire electrode consumption during MIG/MAG welding.....	54
Average shielding gas consumption during MIG/MAG welding.....	54
Average shielding gas consumption during TIG welding.....	54
Technical data.....	55
Explanation of the term "duty cycle".....	55
TransPocket 150 TIG.....	55
TransPocket 180 TIG.....	56
TransPocket 180 TIG MV.....	57
Overview with critical raw materials, year of production of the device.....	59

# Safety rules

## Explanation of safety notices

### **DANGER!**

**Indicates immediate danger.**

- ▶ If not avoided, death or serious injury will result.

### **WARNING!**

**Indicates a potentially hazardous situation.**

- ▶ If not avoided, death or serious injury may result.

### **CAUTION!**

**Indicates a situation where damage or injury could occur.**

- ▶ If not avoided, minor injury and/or damage to property may result.

### **NOTE!**

**Indicates a risk of flawed results and possible damage to the equipment.**

## General

The device is manufactured using state-of-the-art technology and according to recognised safety standards. If used incorrectly or misused, however, it can cause:

- injury or death to the operator or a third party,
- damage to the device and other material assets belonging to the operating company,
- inefficient operation of the device.

All persons involved in commissioning, operating, maintaining and servicing the device must:

- be suitably qualified,
- have sufficient knowledge of welding and
- read and follow these operating instructions carefully.

The operating instructions must always be at hand wherever the device is being used. In addition to the operating instructions, attention must also be paid to any generally applicable and local regulations regarding accident prevention and environmental protection.

All safety and danger notices on the device

- must be in a legible state,
- must not be damaged,
- must not be removed,
- must not be covered, pasted or painted over.

For the location of the safety and danger notices on the device, refer to the section headed "General" in the operating instructions for the device.

Before switching on the device, rectify any faults that could compromise safety.

**This is for your personal safety!**

---

**Proper use**

The device is to be used exclusively for its intended purpose.

---

The device is intended solely for the welding processes specified on the rating plate.

Any use above and beyond this purpose is deemed improper. The manufacturer shall not be held liable for any damage arising from such usage.

---

Proper use includes:

- carefully reading and following all the instructions given in the operating instructions
- studying and obeying all safety and danger notices carefully
- performing all stipulated inspection and maintenance work.

---

Never use the device for the following purposes:

- Thawing out pipes
- Charging batteries
- Starting engines

---

The device is designed for use in industry and the workshop. The manufacturer accepts no responsibility for any damage caused through use in a domestic setting.

---

The manufacturer likewise accepts no liability for inadequate or incorrect results.

---

**Environmental conditions**

Operation or storage of the device outside the stipulated area will be deemed as not in accordance with the intended purpose. The manufacturer shall not be held liable for any damage arising from such usage.

---

Ambient temperature range:

- during operation: -10 °C to + 40 °C (14 °F to 104 °F)
- during transport and storage: -20 °C to +55 °C (-4 °F to 131 °F)

---

Relative humidity:

- up to 50% at 40 °C (104 °F)
- up to 90% at 20 °C (68 °F)

---

The surrounding air must be free from dust, acids, corrosive gases or substances, etc.

Can be used at altitudes of up to 2000 m (6561 ft. 8.16 in.)

---

**Obligations of the operator**

The operator must only allow persons to work with the device who:

- are familiar with the fundamental instructions regarding safety at work and accident prevention and have been instructed in how to use the device
- have read and understood these operating instructions, especially the section "safety rules", and have confirmed as much with their signatures
- are trained to produce the required results.

---

Checks must be carried out at regular intervals to ensure that operators are working in a safety-conscious manner.

---

**Obligations of personnel**

Before using the device, all persons instructed to do so undertake:

- to observe the basic instructions regarding safety at work and accident prevention
  - to read these operating instructions, especially the "Safety rules" section and sign to confirm that they have understood them and will follow them.
-

Before leaving the workplace, ensure that people or property cannot come to any harm in your absence.

### Mains connection

Devices with a higher rating may affect the energy quality of the mains due to their current consumption.

This may affect a number device types in terms of:

- Connection restrictions
- Criteria with regard to the maximum permissible mains impedance <sup>\*)</sup>
- Criteria with regard to the minimum short-circuit power requirement <sup>\*)</sup>

<sup>\*)</sup> at the interface with the public grid  
see "Technical data"

In this case, the plant operator or the person using the device should check whether the device may be connected, where appropriate by discussing the matter with the power supply company.

**IMPORTANT!** Ensure that the mains connection is earthed properly

### Residual current protective device

Local regulations and national guidelines may require a residual current protective device when connecting equipment to the public grid.  
The type of residual current protective device recommended by the manufacturer for the equipment is indicated in the technical data.

### Protecting yourself and others

Anyone working with the device exposes themselves to numerous risks, e.g.

- flying sparks and hot pieces of metal
- Arc radiation, which can damage eyes and skin
- Hazardous electromagnetic fields, which can endanger the lives of those using cardiac pacemakers
- Risk of electrocution from mains current and welding current
- Greater noise pollution
- Harmful welding fumes and gases

Suitable protective clothing must be worn when working with the device. The protective clothing must have the following properties:

- Flame-resistant
- Insulating and dry
- Covers the whole body, is undamaged and in good condition
- Safety helmet
- Trousers with no turn-ups

Protective clothing refers to a variety of different items. Operators should:

- Protect eyes and face from UV rays, heat and sparks using a protective visor and regulation filter
- Wear regulation protective goggles with side protection behind the protective visor
- Wear stout footwear that provides insulation even in wet conditions
- Protect the hands with suitable gloves (electrically insulated and providing protection against heat)
- Wear ear protection to reduce the harmful effects of noise and to prevent injury

Keep all persons, especially children, out of the working area while any devices are in operation or welding is in progress. If, however, there are people in the vicinity:

- Make them aware of all the dangers (risk of dazzling by the arc, injury from flying sparks, harmful welding fumes, noise, possible risks from mains current and welding current, etc.)
- Provide suitable protective equipment
- Alternatively, erect suitable safety screens/curtains.

---

**Noise emission values**

The device generates a maximum sound power level of <80 dB(A) (ref. 1pW) when idling and in the cooling phase following operation at the maximum permissible operating point under maximum rated load conditions according to EN 60974-1.

---

It is not possible to provide a workplace-related emission value during welding (or cutting) as this is influenced by both the process and the environment. All manner of different welding parameters come into play, including the welding process (MIG/MAG, TIG welding), the type of power selected (DC or AC), the power range, the type of weld metal, the resonance characteristics of the workpiece, the workplace environment, etc.

---

**Danger from toxic gases and vapours**

The fumes produced during welding contain harmful gases and vapours.

---

Welding fumes contain substances that cause cancer, as stated in Monograph 118 of the International Agency for Research on Cancer.

---

Use at-source extraction and a room extraction system.  
If necessary, use a welding torch with an integrated extraction device.

---

Keep your face away from welding fumes and gases.

---

Fumes and hazardous gases

- must not be breathed in
- must be extracted from the working area using appropriate methods.

---

Ensure an adequate supply of fresh air. Ensure that there is a ventilation rate of at least 20 m<sup>3</sup> per hour at all times.

---

Otherwise, a welding helmet with an air supply must be worn.

---

If there is any doubt about whether the extraction capacity is sufficient, the measured toxic emission values should be compared with the permissible limit values.

---

The following components are responsible, amongst other things, for the degree of toxicity of welding fumes:

- Metals used for the workpiece
- Electrodes
- Coatings
- Cleaners, degreasers, etc.
- Welding process used

---

The relevant material safety data sheets and manufacturer's specifications for the listed components should therefore be studied carefully.

---

Recommendations for trade fair scenarios, risk management measures and for identifying working conditions can be found on the European Welding Association website under Health & Safety (<https://european-welding.org>).

---



Flammable vapours (e.g. solvent fumes) should be kept away from the arc's radiation area.

Close the shielding gas cylinder valve or main gas supply if no welding is taking place.

### **Danger from flying sparks**

Flying sparks may cause fires or explosions.

Never weld close to flammable materials.

Flammable materials must be at least 11 metres (36 ft. 1.07 in.) away from the arc, or alternatively covered with an approved cover.

A suitable, tested fire extinguisher must be available and ready for use.

Sparks and pieces of hot metal may also get into adjacent areas through small gaps or openings. Take appropriate precautions to prevent any danger of injury or fire.

Welding must not be performed in areas that are subject to fire or explosion or near sealed tanks, vessels or pipes unless these have been prepared in accordance with the relevant national and international standards.

Do not carry out welding on containers that are being or have been used to store gases, propellants, mineral oils or similar products. Residues pose an explosive hazard.

### **Risks from mains current and welding current**

An electric shock is potentially life threatening and can be fatal.

Do not touch live parts either inside or outside the device.

During MIG/MAG welding and TIG welding, the welding wire, the wirespool, the feed rollers and all pieces of metal that are in contact with the welding wire are live.

Always set the wirefeeder up on a sufficiently insulated surface or use a suitable, insulated wirefeeder holder.

Make sure that you and others are protected with an adequately insulated, dry base or cover for the earth or ground potential. This base or cover must extend over the entire area between the body and the earth or ground potential.

All cables and leads must be secured, undamaged, insulated and adequately dimensioned. Replace loose connections and scorched, damaged, or inadequately dimensioned cables and leads immediately.

Use the handle to ensure the power connections are tight before every use. In the case of power cables with a bayonet connector, rotate the power cable around the longitudinal axis by at least 180° and pretension.

Do not wrap cables or leads around the body or parts of the body.

The electrode (rod electrode, tungsten electrode, welding wire, etc.) must

- never be immersed in liquid for cooling
- Never touch the electrode when the power source is switched on.

Double the open circuit voltage of a power source can occur between the welding electrodes of two power sources. Touching the potentials of both electrodes at the same time may be fatal under certain circumstances.

Arrange for the mains cable to be checked regularly by a qualified electrician to ensure the ground conductor is functioning properly.

---

Protection class I devices require a mains supply with ground conductor and a connector system with ground conductor contact for proper operation.

---

Operation of the device on a mains supply without ground conductor and on a socket without ground conductor contact is only permitted if all national regulations for protective separation are observed.

Otherwise, this is considered gross negligence. The manufacturer shall not be held liable for any damage arising from such usage.

---

If necessary, provide adequate earthing for the workpiece.

---

Switch off unused devices.

---

Wear a safety harness if working at height.

---

Before working on the device, switch it off and pull out the mains plug.

---

Attach a clearly legible and easy-to-understand warning sign to the device to prevent anyone from plugging the mains plug back in and switching it on again.

---

After opening the device:

- Discharge all live components
  - Ensure that all components in the device are de-energised.
- 

If work on live parts is required, appoint a second person to switch off the main switch at the right moment.

---

---

### **Meandering welding currents**

If the following instructions are ignored, meandering welding currents can develop with the following consequences:

- Fire hazard
  - Overheating of parts connected to the workpiece
  - Damage to ground conductors
  - Damage to device and other electrical equipment
- 

Ensure that the workpiece is held securely by the workpiece clamp.

---

Attach the workpiece clamp as close as possible to the area that is to be welded.

---

Position the device with sufficient insulation against electrically conductive environments, such as insulation against conductive floor or insulation to conductive racks.

---

If power distribution boards, twin-head mounts, etc., are being used, note the following: The electrode of the welding torch / electrode holder that is not used is also live. Make sure that the welding torch / electrode holder that is not used is kept sufficiently insulated.

---

In the case of automated MIG/MAG applications, ensure that only an insulated wire electrode is routed from the welding wire drum, large wirefeeder spool or wirespool to the wirefeeder.

---

---

### **EMC Device Classifications**

Devices in emission class A:

- Are only designed for use in industrial settings
  - Can cause line-bound and radiated interference in other areas
- 

Devices in emission class B:

- Satisfy the emissions criteria for residential and industrial areas. This is also true for residential areas in which the energy is supplied from the public low-voltage mains.
-

---

**EMC measures**

In certain cases, even though a device complies with the standard limit values for emissions, it may affect the application area for which it was designed (e.g. when there is sensitive equipment at the same location, or if the site where the device is installed is close to either radio or television receivers).

If this is the case, then the operator is obliged to take appropriate action to rectify the situation.

---

Check and evaluate the immunity to interference of nearby devices according to national and international regulations. Examples of equipment that may be susceptible to interference from the device include:

- Safety devices
- Network, signal and data transfer lines
- IT and telecommunications devices
- Measuring and calibrating devices

---

Supporting measures for avoidance of EMC problems:

1. Mains supply
  - If electromagnetic interference arises despite the correct mains connection, additional measures are necessary (e.g. use of a suitable line filter)
2. Welding power-leads
  - must be kept as short as possible
  - must be laid close together (to avoid EMF problems)
  - must be kept well apart from other leads
3. Equipotential bonding
4. Earthing of the workpiece
  - If necessary, establish an earth connection using suitable capacitors.
5. Shield, if necessary
  - Shield other devices nearby
  - Shield the entire welding installation

---

**EMF measures**

Electromagnetic fields may pose as yet unknown risks to health:

- Effects on the health of persons in the vicinity, e.g. those with pacemakers and hearing aids
- Individuals with pacemakers must seek advice from their doctor before approaching the device or any welding that is in progress
- For safety reasons, maintain as large a distance as possible between the welding power-leads and the head/torso of the welder
- Do not carry welding power-leads and hosepacks over the shoulders or wind them around any part of the body

---

**Specific hazards**

Keep hands, hair, clothing and tools away from moving parts. For example:

- Fans
- Cogs
- Rollers
- Shafts
- Wirespools and welding wires

---

Do not reach into the rotating cogs of the wire drive or into rotating drive components.

---

Covers and side panels may only be opened/removed while maintenance or repair work is being carried out.

---

During operation

- Ensure that all covers are closed and all side panels are fitted properly.
- Keep all covers and side panels closed.

---

The welding wire emerging from the welding torch poses a high risk of injury (piercing of the hand, injuries to the face and eyes, etc.).

---

Therefore, always keep the welding torch away from the body (devices with wirefeeder) and wear suitable protective goggles.

---

Never touch the workpiece during or after welding - risk of burns.

---

Slag can jump off cooling workpieces. The specified protective equipment must therefore also be worn when reworking workpieces, and steps must be taken to ensure that other people are also adequately protected.

---

Welding torches and other parts with a high operating temperature must be allowed to cool down before handling.

---

Special provisions apply in areas at risk of fire or explosion

- observe relevant national and international regulations.

---

Power sources for work in areas with increased electric risk (e.g. near boilers) must carry the "Safety" sign. However, the power source must not be located in such areas.

---

Risk of scalding from escaping coolant. Switch off cooling unit before disconnecting coolant flow or return lines.

---

Observe the information on the coolant safety data sheet when handling coolant. The coolant safety data sheet may be obtained from your service centre or downloaded from the manufacturer's website.

---

Use only suitable load-carrying equipment supplied by the manufacturer when transporting devices by crane.

- Hook chains or ropes onto all suspension points provided on the load-carrying equipment.
- Chains and ropes must be at the smallest angle possible to the vertical.
- Remove gas cylinder and wirefeeder (MIG/MAG and TIG devices).

---

If the wirefeeder is attached to a crane holder during welding, always use a suitable, insulated wirefeeder hoisting attachment (MIG/MAG and TIG devices).

---

If the device has a carrying strap or handle, this is intended solely for carrying by hand. The carrying strap is not to be used if transporting with a crane, counter-balanced lift truck or other mechanical hoist.

---

All lifting tackle (straps, handles, chains, etc.) used in connection with the device or its components must be tested regularly (e.g. for mechanical damage, corrosion or changes caused by other environmental factors).

The testing interval and scope of testing must comply with applicable national standards and directives as a minimum.

---

Odourless and colourless shielding gas may escape unnoticed if an adapter is used for the shielding gas connection. Prior to assembly, seal the device-side thread of the adapter for the shielding gas connection using suitable Teflon tape.

---

### **Requirement for the shielding gas**

Especially with ring lines, contaminated shielding gas can cause damage to equipment and reduce welding quality.

Meet the following requirements regarding shielding gas quality:

- Solid particle size < 40 µm
- Pressure condensation point < -20 °C
- Max. oil content < 25 mg/m<sup>3</sup>

---

Use filters if necessary.

---

### **Danger from shielding gas cylinders**

Shielding gas cylinders contain gas under pressure and can explode if damaged. As the shielding gas cylinders are part of the welding equipment, they must be handled with the greatest of care.

---

Protect shielding gas cylinders containing compressed gas from excessive heat, mechanical impact, slag, naked flames, sparks and arcs.

---

Mount the shielding gas cylinders vertically and secure according to instructions to prevent them falling over.

---

Keep the shielding gas cylinders well away from any welding or other electrical circuits.

---

Never hang a welding torch on a shielding gas cylinder.

---

Never touch a shielding gas cylinder with an electrode.

---

Risk of explosion - never attempt to weld a pressurised shielding gas cylinder.

---

Only use shielding gas cylinders suitable for the application in hand, along with the correct and appropriate accessories (regulator, hoses and fittings). Only use shielding gas cylinders and accessories that are in good condition.

---

Turn your face to one side when opening the valve of a shielding gas cylinder.

---

Close the shielding gas cylinder valve if no welding is taking place.

---

If the shielding gas cylinder is not connected, leave the valve cap in place on the cylinder.

---

The manufacturer's instructions must be observed as well as applicable national and international regulations for shielding gas cylinders and accessories.

---

### **Safety measures at the installation location and during transport**

A device toppling over could easily kill someone. Place the device on a solid, level surface such that it remains stable

- The maximum permissible tilt angle is 10°.

---

Special regulations apply in rooms at risk of fire or explosion

- Observe relevant national and international regulations.

---

Use internal directives and checks to ensure that the workplace environment is always clean and clearly laid out.

---

Only set up and operate the device in accordance with the degree of protection shown on the rating plate.

---

When setting up the device, ensure there is an all-round clearance of 0.5 m (1 ft. 7.69 in.) to ensure that cooling air can flow in and out freely.

---

When transporting the device, observe the relevant national and local guidelines and accident prevention regulations. This applies especially to guidelines regarding the risks arising during transport.

---

Do not lift or transport operational devices. Switch off devices before transport or lifting.

---

Before transporting the device, allow coolant to drain completely and detach the following components:

- Wirefeeder
- Wirespool
- Shielding gas cylinder

---

After transporting the device, the device must be visually inspected for damage before commissioning. Any damage must be repaired by trained service technicians before commissioning the device.

---

**Safety measures in normal operation**

Only operate the device when all safety devices are fully functional. If the safety devices are not fully functional, there is a risk of

- injury or death to the operator or a third party
- damage to the device and other material assets belonging to the operator
- inefficient operation of the device

---

Any safety devices that are not functioning properly must be repaired before switching on the device.

---

Never bypass or disable safety devices.

---

Before switching on the device, ensure that no one is likely to be endangered.

---

Check the device at least once a week for obvious damage and proper functioning of safety devices.

---

Always fasten the shielding gas cylinder securely and remove it beforehand if the device is to be transported by crane.

---

Only the manufacturer's original coolant is suitable for use with our devices due to its properties (electrical conductivity, anti-freeze agent, material compatibility, flammability, etc.).

---

Only use suitable original coolant from the manufacturer.

---

Do not mix the manufacturer's original coolant with other coolants.

---

Only connect the manufacturer's system components to the cooling circuit.

---

The manufacturer accepts no liability for damage resulting from use of other system components or a different coolant. In addition, all warranty claims will be forfeited.

---

Cooling Liquid FCL 10/20 does not ignite. The ethanol-based coolant can ignite under certain conditions. Transport the coolant only in its original, sealed containers and keep well away from any sources of ignition.

---

Used coolant must be disposed of properly in accordance with the relevant national and international regulations. The coolant safety data sheet may be obtained from your service centre or downloaded from the manufacturer's website.

---

Check the coolant level before starting to weld, while the system is still cool.

---

**Commissioning, maintenance and repair**

It is impossible to guarantee that bought-in parts are designed and manufactured to meet the demands made of them, or that they satisfy safety requirements.

- Use only original spare and wearing parts (also applies to standard parts).
- Do not carry out any modifications, alterations, etc. to the device without the manufacturer's consent.
- Components that are not in perfect condition must be replaced immediately.
- When ordering, please give the exact designation and part number as shown in the spare parts list, as well as the serial number of your device.

---

The housing screws provide the ground conductor connection for earthing the housing parts.

Only use original housing screws in the correct number and tightened to the specified torque.

---

### **Safety inspection**

The manufacturer recommends that a safety inspection of the device is performed at least once every 12 months.

---

The manufacturer recommends that the power source be calibrated during the same 12-month period.

---

A safety inspection should be carried out by a qualified electrician

- after any changes are made
- after any additional parts are installed, or after any conversions
- after repair, care and maintenance has been carried out
- at least every twelve months.

---

For safety inspections, follow the appropriate national and international standards and directives.

---

Further details on safety inspection and calibration can be obtained from your service centre. They will provide you on request with any documents you may require.

---

### **Disposal**

Do not dispose of this device with normal domestic waste! To comply with the European Directive on Waste Electrical and Electronic Equipment and its implementation as national law, electrical equipment that has reached the end of its life must be collected separately and returned to an approved recycling facility. Any device that you no longer require must either be returned to your dealer or given to one of the approved collection and recycling facilities in your area. Ignoring this European Directive may have potentially adverse effects on the environment and your health!

---

### **Safety symbols**

Devices with the CE mark satisfy the essential requirements of the low-voltage and electromagnetic compatibility directives (e.g. relevant product standards of the EN 60 974 series).

Fronius International GmbH hereby declares that the device is compliant with Directive 2014/53/EU. The full text on the EU Declaration of Conformity can be found at the following address: <http://www.fronius.com>

---

Devices marked with the CSA test mark satisfy the requirements of the relevant standards for Canada and the USA.

---

### **Data protection**

The user is responsible for the safekeeping of any changes made to the factory settings. The manufacturer accepts no liability for any deleted personal settings.

---

**Copyright**

Copyright of these operating instructions remains with the manufacturer.

---

The text and illustrations are all technically correct at the time of printing. We reserve the right to make changes. The contents of the operating instructions shall not provide the basis for any claims whatsoever on the part of the purchaser. If you have any suggestions for improvement, or can point out any mistakes that you have found in the instructions, we will be most grateful for your comments.



## Device concept

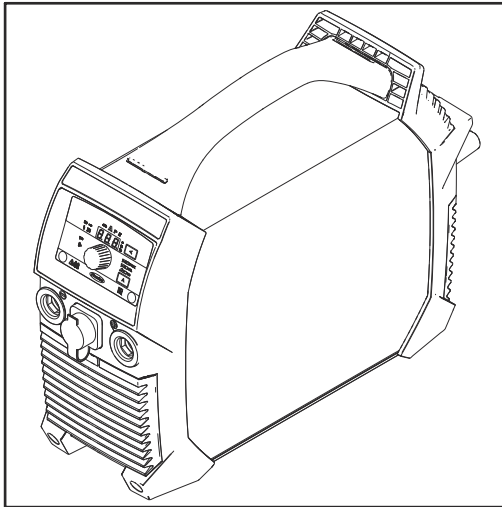

The power source has the following properties:

- Compact dimensions
- Robust plastic housing
- Extremely reliable even under harsh operating conditions
- Carrying strap for easy transport on construction sites, etc.
- Protected controls
- Current sockets with bayonet latch

In conjunction with the digital resonance inverter, an electronic regulator adapts the power source characteristic to suit the welding electrode during welding. The result is a lightweight and compact device with excellent ignition and weld properties.

The power source also features a Power Factor Correction, which adapts the current consumption of the power source to the sinusoidal mains voltage. This results in numerous advantages for the user, such as:

- Low primary current
- Low conduction losses
- Late tripping of the circuit breaker
- Improved stability in the event of voltage fluctuations
- Long mains leads can be used
- In the case of multivoltage devices, a continuous input voltage range

When using cellulose electrodes (CEL), a dedicated operating mode can be chosen for perfect welding results.

TIG welding with touchdown ignition greatly extends the range of applications.

## Warning notices on the device

The warning notices and safety symbols on the power source must not be removed or painted over. They warn against incorrect operation which can lead to serious injury and damage.

### Meaning of safety symbols on the device:



Welding is dangerous. The following basic requirements must be met to ensure the equipment is used properly:

- Welders must be sufficiently qualified
- Suitable protective equipment must be used
- All persons not involved must be kept at a safe distance from the welding process



Do not use the functions described here until you have fully read and understood the following documents:

- These Operating Instructions
- all the Operating Instructions for the system components of the power source, especially the safety rules



Do not dispose of used devices with domestic waste. Dispose of them according to the safety rules.

<b>WARNING</b>		Read American National Standard Z49.1, "Safety in Welding and Cutting" From American Welding Society, 550 N.W. LeJeune Rd., Miami, FL 33126; OSHA Safety and Health Standards, 29 CFR 1910, from U.S. Government Printing Office, Washington, DC 20402. CSA, W117-2 M87 Code for Safety in Welding and Cutting. 42.0409.5074	
<b>Do not Remove, Destroy, Or Cover This Label</b>			
<b>ARC WELDING can be hazardous.</b> <ul style="list-style-type: none"> <li>Read and follow all labels and the Owner's Manual carefully</li> <li>Only qualified persons are to install, operate, or service this unit according to all applicable codes and safety practices.</li> <li>Keep children away.</li> <li>Pacemaker wearers keep away.</li> <li>Welding wire and drive parts may be at welding voltage.</li> </ul>	<b>EXPLODING PARTS can injure.</b> <ul style="list-style-type: none"> <li>Failed parts can explode or cause other parts to explode when power is applied.</li> <li>Always wear a face shield and long sleeves when servicing.</li> </ul>		
<b>ELECTRIC SHOCK can kill.</b> <ul style="list-style-type: none"> <li>Always wear dry insulating gloves.</li> <li>Insulate yourself from work and ground.</li> <li>Do not touch live electrical parts.</li> <li>Disconnect input power before servicing.</li> <li>Keep all panels and covers securely in place.</li> </ul>	<b>ELECTRIC SHOCK can kill; SIGNIFICANT DC VOLTAGE exists after removal of input power</b> <ul style="list-style-type: none"> <li>Always wait 60 seconds after power is turned off before working on unit.</li> <li>Check input capacitor voltage, and be sure it is near 0 before touching parts.</li> </ul>		
<b>FUMES AND GASES can be hazardous.</b> <ul style="list-style-type: none"> <li>Keep your head out of the fumes.</li> <li>Ventilate area, or use breathing device.</li> <li>Read Material Safety Data Sheets (MSDSs) and manufacturer's instructions for materials used.</li> </ul>	<b>AVERTISSEMENT</b>		
<b>WELDING can cause fire or explosion.</b> <ul style="list-style-type: none"> <li>Do not weld near flammable material.</li> <li>Watch for fire: keep extinguisher nearby.</li> <li>Do not locate unit over combustible surfaces.</li> <li>Do not weld on closed containers.</li> </ul>	<b>UN CHOC ELECTRIQUE peut etre mortel.</b> <ul style="list-style-type: none"> <li>Installation et raccordement de cette machine doivent etre conformes a tous les pertinents.</li> </ul> <b>SOUDEGE A L'ARC peut etre hasardeux.</b> <ul style="list-style-type: none"> <li>Lire le manuel d' instructions avant utilisation.</li> <li>Ne pas installer sur une surface combustible.</li> <li>Les fils de soudage et pieces conductrices peuvent etre a la tension de soudage.</li> </ul>		

## Application areas

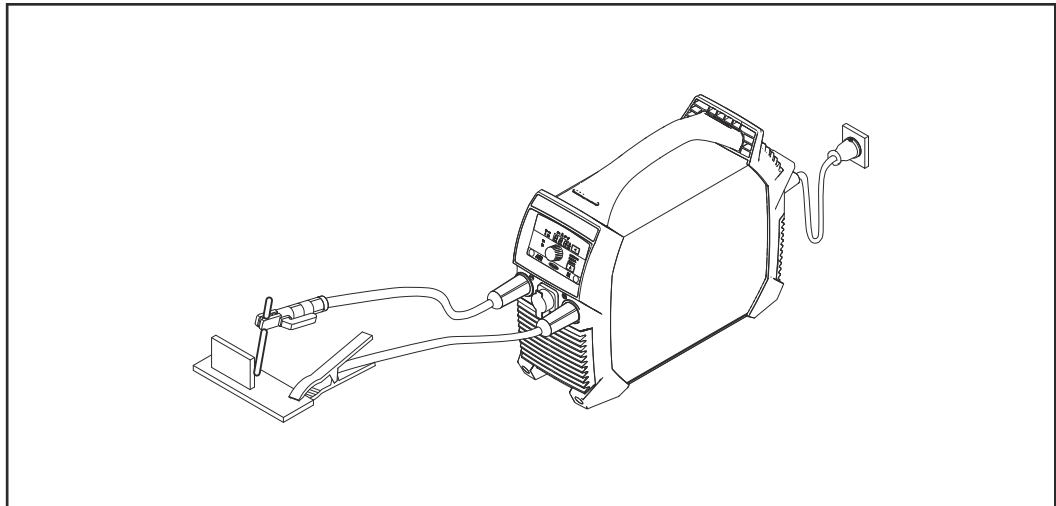

MMA welding

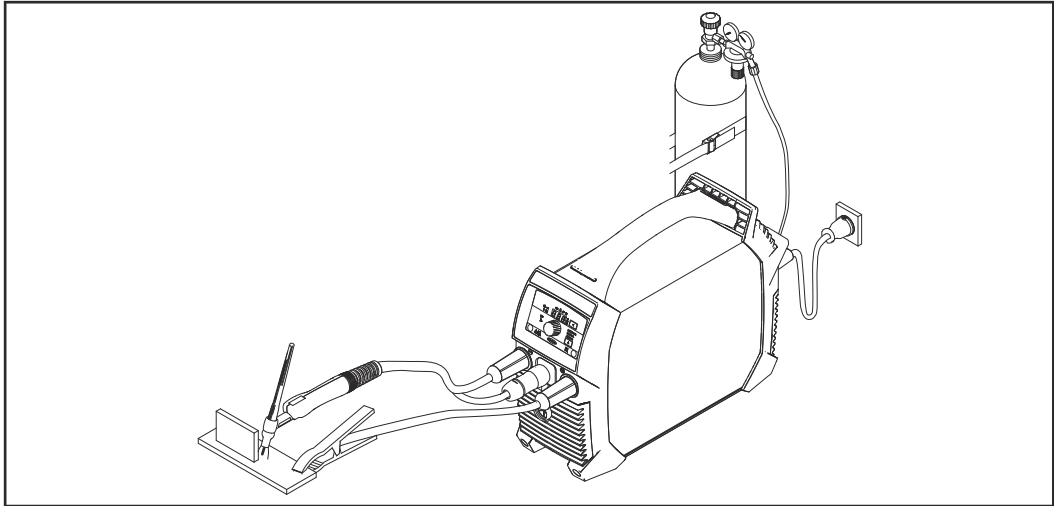

*TIG welding, welding torch with torch trigger and TIG Multi Connector plug*

# Before commissioning

---

## Safety



### WARNING!

#### **Danger from incorrect operation and work that is not carried out properly.**

This can result in serious personal injury and damage to property.

- ▶ All the work and functions described in this document must only be carried out by technically trained and qualified personnel.
  - ▶ Read and understand this document in full.
  - ▶ Read and understand all safety rules and user documentation for this device and all system components.
- 

## Proper use

The power source is intended exclusively for MMA welding and TIG welding in conjunction with system components from Fronius.

Utilisation for any other purpose, or in any other manner, shall be deemed to be not in accordance with the intended purpose.

The manufacturer shall not be held liable for any damages arising from such usage.

Proper use also includes:

- carefully reading these operating instructions
  - following all the instructions and safety rules in these operating instructions
  - performing all stipulated inspection and maintenance work
- 

## Setup regulations



### WARNING!

#### **Danger from machines toppling over or falling.**

This can result in serious personal injury and damage to property.

- ▶ Set up the device securely on an even, solid surface.
  - ▶ Check all screw connections are tightly fastened after installation.
- 

The device is tested to IP 23 protection, meaning:

- Protection against penetration by solid foreign bodies with diameters > 12.5 mm (0.49 in.)
- Protected against spraywater at any angle up to 60° to the vertical

#### **Cooling air**

The device must be set up in such a way that cooling air can flow freely through the slots in the front and rear panels.

#### **Dust**

Ensure that metallic dust is not sucked into the system by the fan, when carrying out grinding for example.

#### **Outdoor operation**

The device can be set up and operated outdoors in accordance with IP23 degree of protection. Avoid direct wetting (e.g. from rain).

---

**Generator-powered operation**

The power source is generator-compatible.

In order to dimension the required generator output, the maximum apparent power  $S_{1\max}$  of the power source is required.

The maximum apparent power  $S_{1\max}$  of the power source can be calculated as follows:

$$S_{1\max} = I_{1\max} \times U_1$$

See device rating plate or technical data for  $I_{1\max}$  and  $U_1$  values

The generator apparent power  $S_{\text{GEN}}$  needed is calculated using the following rule of thumb:

$$S_{\text{GEN}} = S_{1\max} \times 1.35$$

A smaller generator may be used when not welding at full power.

**IMPORTANT!** The generator apparent power  $S_{\text{GEN}}$  must always be higher than the maximum apparent power  $S_{1\max}$  of the power source.

When using single-phase devices with a 3-phase generator, note that the specified generator apparent power is often only available as a whole across all three phases of the generator. If necessary, obtain further information on the single-phase power of the generator from the generator manufacturer.

**NOTE!**

**The voltage delivered by the generator must never exceed the upper or lower limits of the mains voltage tolerance range.**

Details of the mains voltage tolerance can be found in the "Technical data" section.

---

# Controls, connections and mechanical components

---

## Safety



### **WARNING!**

**Danger from incorrect operation and work that is not carried out properly.**

This can result in serious personal injury and damage to property.

- ▶ All the work and functions described in this document must only be carried out by technically trained and qualified personnel.
  - ▶ Read and understand this document in full.
  - ▶ Read and understand all safety rules and user documentation for this device and all system components.
- 

As a result of software updates, you may find that there are functions available on your device that are not described in these Operating Instructions, or vice versa.

Certain illustrations may also differ slightly from the actual controls on your device, but these controls function in exactly the same way.

## TransPocket 150 controls, connections and mechanical components

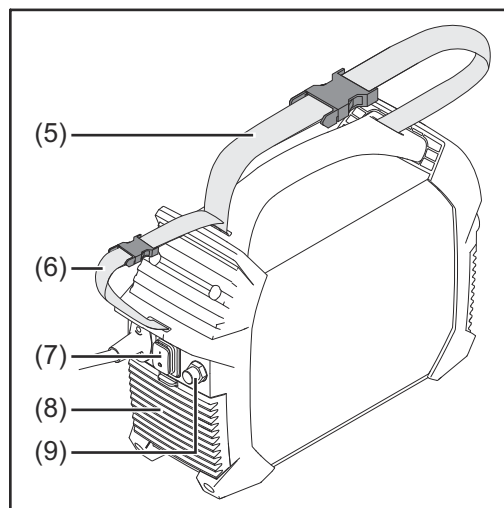
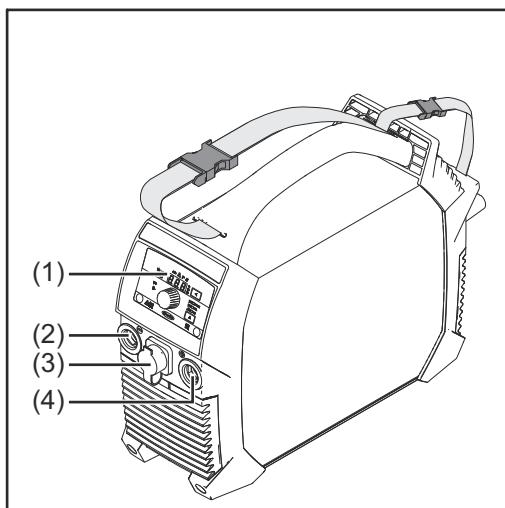

**(1) Control panel**

**(2) (-) current socket**  
with bayonet latch

**(3) TMC connection (TIG Multi Connector)**

After connecting a remote control to the power source

- 'rc' appears on the power source display
- the welding current can only be adjusted using the remote control

**(4) (+) current socket**  
with bayonet latch

**(5) Carrying strap**

**(6) Cable strap**  
for holding the mains cable and the welding power-leads  
Do not use to move the device!

**(7) Mains switch**

**(8) Air filter**

**(9) Shielding gas connection**

**Use of the current connections during manual metal arc welding (depending on electrode type):**

- **(+) current socket** for electrode holder or grounding cable
- **(-) current socket** for electrode holder or grounding cable

**Use of the current connections during TIG welding:**

- **(+) current socket** for grounding cable
- **(-) current socket** for welding torch

**TransPocket 180  
controls, con-  
nections and  
mechanical com-  
ponents**

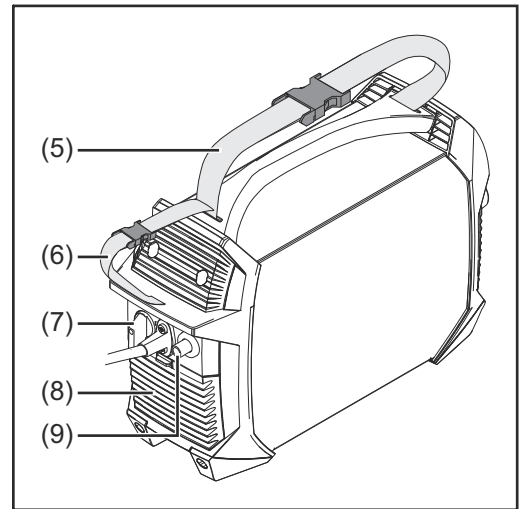
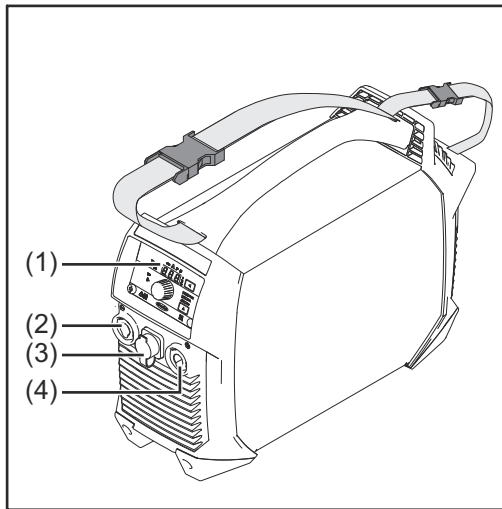

---

**(1) Control panel**

---

**(2) (-) current socket**  
with bayonet latch

---

**(3) TMC connection (TIG Multi Connector)**

After connecting a remote control to the power source

- 'rc' appears on the power source display
- the welding current can only be adjusted using the remote control

---

**(4) (+) current socket**  
with bayonet latch

---

**(5) Carrying strap**

---

**(6) Cable strap**  
for holding the mains cable and the welding power-leads  
Do not use to move the device!

---

**(7) Mains switch**

---

**(8) Air filter**

---

**(9) Shielding gas connection**

---

**Use of the current connections during manual metal arc welding (depending on electrode type):**

- **(+) current socket** for electrode holder or grounding cable
- **(-) current socket** for electrode holder or grounding cable

**Use of the current connections during TIG welding:**





- **(+) current socket** for grounding cable
- **(-) current socket** for welding torch

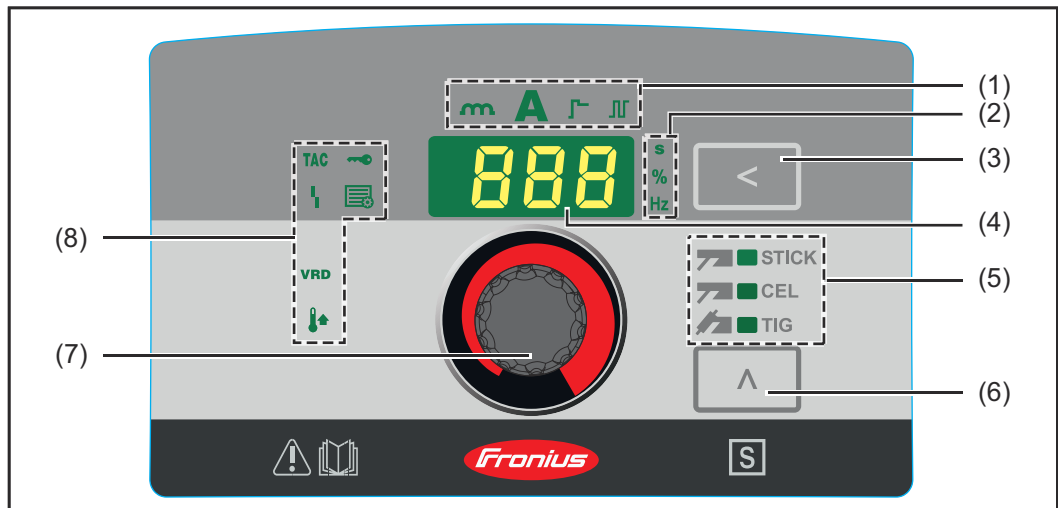



## Control panel



**(1) Setting value indicator**  
shows which setting value is selected:

- Arc-force dynamic 
- Welding current 
- SoftStart / HotStart function 
- Pulse welding 



**(2) Unit indicator**  
shows the unit of the value that is currently being changed with the adjusting dial (7):

- Time (seconds) 
- Percent 
- Frequency (Hertz) 

**(3) Setting value button**  
for selecting the desired setting value (1)

**(4) Display**  
shows the current figure of the selected setting value

**(5) Welding process indicator**  
shows which welding process is selected:

- MMA welding 
- MMA welding with Cel electrode 
- TIG welding 

**(6) Welding process button**  
for selecting the welding process

---

**(7) Adjusting dial**

for continuous adjustment of the selected setting value (1)

---

**(8) Status indicators**

display various operating modes of the power source:

---

- **VRD**  
lights up when the safety device for voltage reduction is activated (VRD devices only)
- **Setup**  
lights up in Setup mode
- **Temperature**  
lights up when the device is outside the permissible temperature range
- **Fault**  
lights up in the event of a fault, also see section "Troubleshooting"
- **TAC**  
lights up when the tacking function is activated (only on TIG devices with the TIG welding process)



# MMA welding

## Preparation

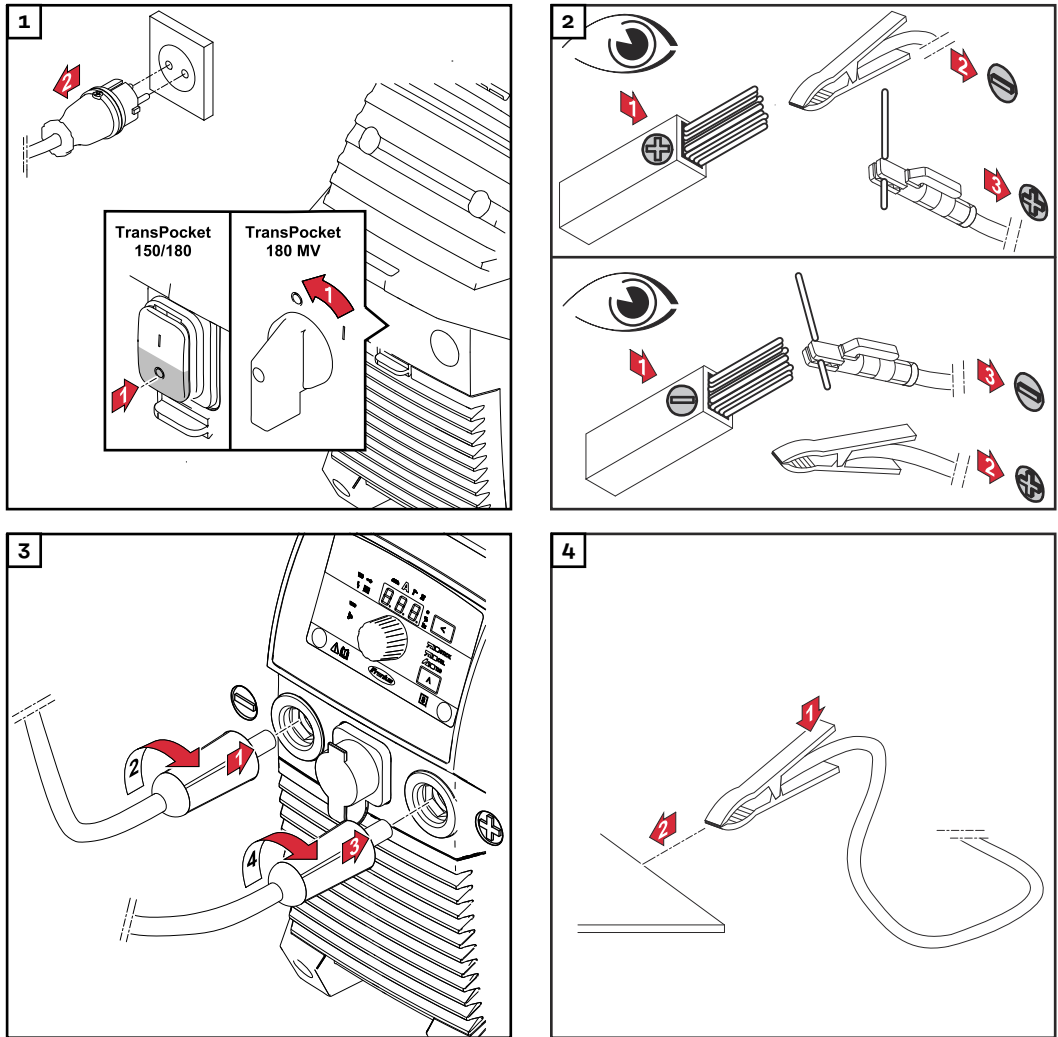

**⚠ CAUTION!**

**Danger from electric shocks. As soon as the power source is switched on, the electrode in the electrode holder is live.**

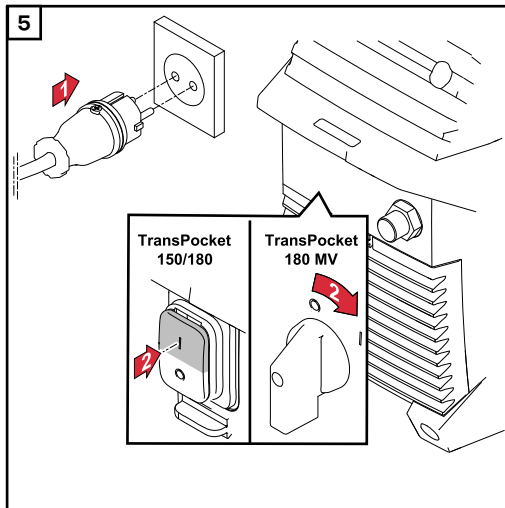

This can result in injury and damage to property.

- Ensure the electrode does not touch any persons or electrically conductive or earthed parts (e.g. the housing, etc.).



## MMA welding

- 1** Use the welding process button to select one of the following processes:

  - MMA welding - the MMA welding indicator lights up after selection 
  - MMA welding with Cel electrode - the MMA welding with Cel electrode indicator lights up after selection 
- 2** Press the setting value button until

  - the welding current indicator lights up 
- 3** Adjust the welding current using the adjusting dial

  - power source is ready for welding 

## SoftStart / Hot-Start function

This function is used to set the starting current.

Setting range: 1 - 200 %

Operating principle:

At the start of the welding process, the welding current is reduced (SoftStart) or increased (HotStart) for 0.5 seconds, depending on the setting.

The change is shown as a percentage from the set welding current.

The duration of the starting current can be changed in the Setup menu using the starting current duration (Hti) parameter.

### Setting the starting current:

- 1** Press the setting value button until

  - the SoftStart / HotStart indicator lights up 

- 2** Turn the adjusting dial until the desired value is reached
- power source is ready for welding



**The maximum HotStart current is limited as follows:**

- TransPocket 150 to 160 A
- TransPocket 180 to 200 A

**Examples (set welding current = 100 A):**

100 % = 100 A starting current = function deactivated

80 % = 80 A starting current = SoftStart

135 % = 135 A starting current = HotStart

200 % = 160 A starting current on TransPocket 150 = HotStart, maximum current limit is reached!

200 % = 200 A starting current on TransPocket 180 = HotStart

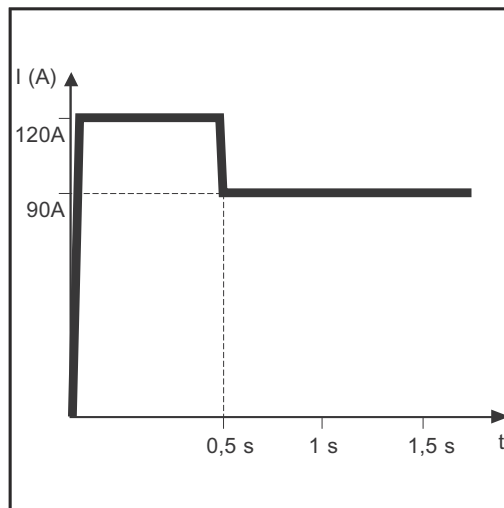

Example of HotStart function

**Features of SoftStart function:**

- Reduced pore formation with certain electrode types

**Features of HotStart function:**

- Improved ignition properties, even when using electrodes with poor ignition properties
- Better fusion of the base material during the start-up phase, meaning fewer cold-shut defects
- Largely prevents slag inclusions

**Arc-force dynamic**

To obtain optimum welding results, it will sometimes be necessary to adjust the arc-force dynamic.

Setting range: 0 - 100 (corresponds to 0 - 200 A current increase)

**Operating principle:**

At the moment of droplet transfer or in the event of a short circuit, the amperage is briefly increased in order to obtain a stable arc.

If the rod electrode threatens to sink into the weld pool, this measure prevents the weld pool solidifying, as well as preventing a prolonged short-circuit of the arc. This largely prevents the rod electrode from sticking.

**Setting the arc-force dynamic:**

- 1** Press the setting value button until



- the arc-force dynamic indicator lights up



- 2 Turn the adjusting dial until the desired correction value is reached
- power source is ready for welding



**The maximum arc-force dynamic current is limited as follows:**

- TransPocket 150 to 180 A
- TransPocket 180 to 220 A

Examples:

- Arc-force dynamic = 0
  - arc-force dynamic deactivated
  - soft, low-spatter arc
- Arc-force dynamic = 20
  - arc-force dynamic with 40 A current increase
  - harder, more stable arc
- Arc-force dynamic = 60, set welding current = 100 A
  - for the TransPocket 150: actual increase is just 80 A as the maximum current limit is reached!
  - for the TransPocket 180: arc-force dynamic with 120 A current increase

**Pulse welding**

Pulse welding is welding with a pulsing welding current. It is used for out-of-position welding of steel pipes or when welding thin sheets.

In these applications, the welding current set at the start of welding is not always ideal for the whole welding process:

- if the amperage is too low, the base material will not melt sufficiently
- if overheating occurs, the liquid weld pool may drip

**Setting range:** 0.2 - 990 Hz

**Operating principle:**

- A low base current I-G rises steeply to the significantly higher pulse current I-P and drops back to the base current I-G after the Duty cycle dcY time. The pulse current I-P can be set on the power source.
- This results in an average current that is lower than the set pulse current I-P.
- During pulse welding, small sections of the welding location melt quickly and then rapidly re-solidify.

**The power source controls the Duty cycle dcY parameter and base current I-G according to the set pulse current and pulse frequency.**

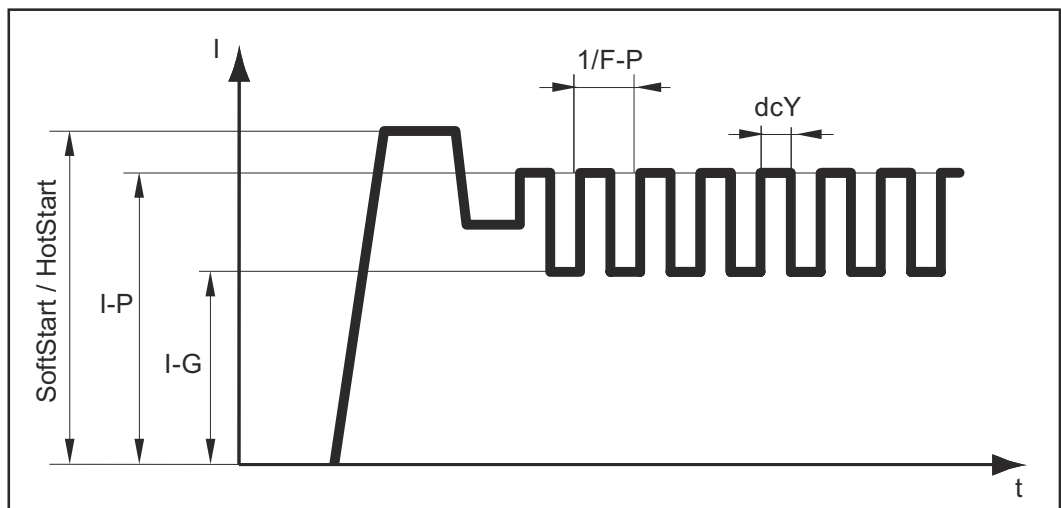

*Pulse welding - welding current curve*



**Adjustable parameters:**

- **F-P:** Pulse frequency ( $1/F-P$  = time interval between two pulses)
- **I-P:** Pulse current
- SoftStart/HotStart

**Fixed parameters:**

- **I-G:** Base current
- **dcY:** Duty cycle

**To use pulse welding:**

- 1**  Press the setting value button until  the pulse welding indicator lights up
- 2**  Turn the adjusting dial until the desired frequency value (Hz) is reached
  - power source is ready for welding

# TIG modes

## Symbols and their explanations

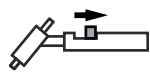

Pull back and hold the torch trigger

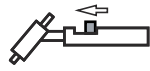

Release the torch trigger forwards



Push forward and hold the torch trigger

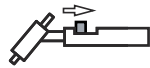

Release the torch trigger backwards

### Adjustable parameters:

- **GPo:** Gas post-flow time
- **I-S:** Starting-current phase - the temperature is raised gently at low welding current, so that the filler metal can be positioned correctly
- **I-E:** Final current phase - to prevent crater cracks or cavitations
- **I-1:** Main current phase (welding-current phase) - uniform thermal input into the base material, whose temperature is raised by the continuous heat
- **I-2:** Reduced current phase - intermediate lowering of the welding current in order to prevent any local overheating of the base material

### Fixed parameters:

- **GPr:** Gas pre-flow time
- **t<sub>up</sub>:** UpSlope phase - the welding current is continually increased  
Duration = 0.5 seconds
- **t<sub>down</sub>:** DownSlope phase - the welding current is continually decreased  
Duration = 0.5 seconds
- **t<sub>S</sub>:** Starting current duration
- **t<sub>E</sub>:** Final current duration

## 2-step mode

See the description [Operating mode \(trigger mode\)](#) on page 43 for details on how to activate 2-step mode.

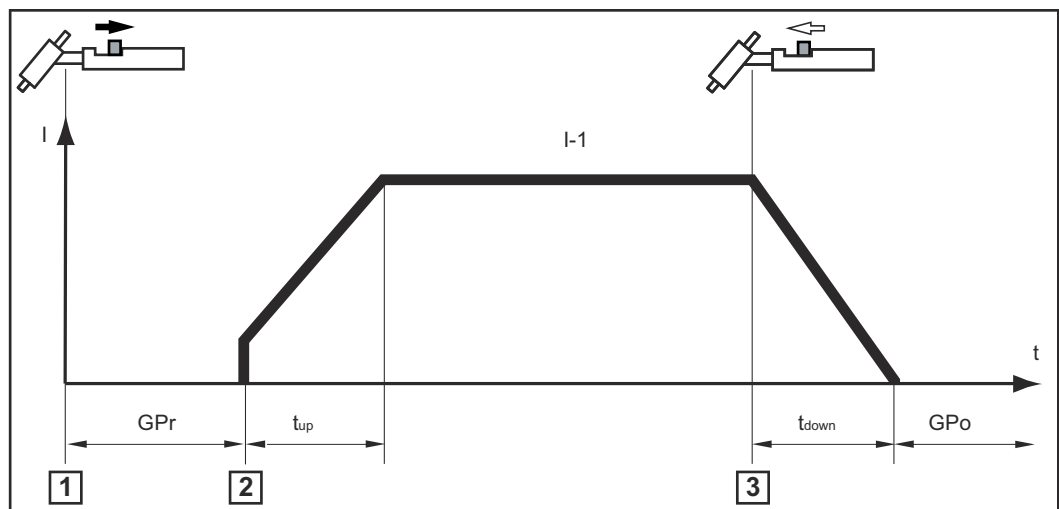

- 1** Place the tungsten electrode onto the workpiece and then pull the torch trigger back and hold => shielding gas flows



- 2 Raise the tungsten electrode => arc ignites
- 3 Release torch trigger => end of welding

#### 4-step mode

See the description [Operating mode \(trigger mode\)](#) on page 43 for details on how to activate 4-step mode.

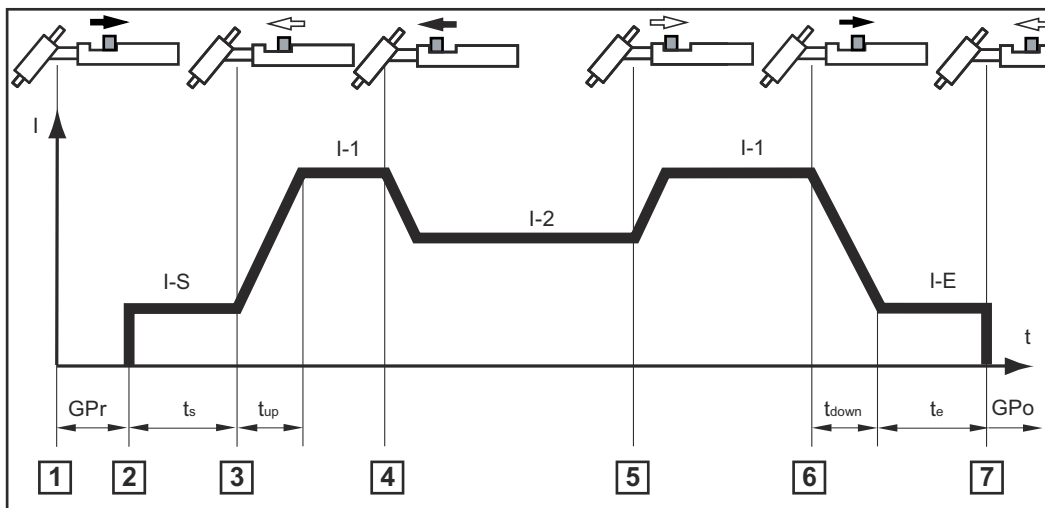

4-step mode with intermediate lowering I-2

Intermediate lowering means that the welder uses the torch trigger during the main current phase to lower the welding current to the specified reduced current I-2.

- 1 Place the tungsten electrode onto the workpiece and then pull the torch trigger back and hold => shielding gas flows
- 2 Raise the tungsten electrode => start of welding with starting current I-S
- 3 Release torch trigger => welding with main current I-1
- 4 Push forward and hold the torch trigger => activation of intermediate lowering with reduced current I-2
- 5 Release torch trigger => welding with main current I-1
- 6 Pull back and hold the torch trigger => lowering to final current I-E
- 7 Release torch trigger => end of welding

# TIG welding

## General

### NOTE!

Do not use pure tungsten electrodes (colour-coded green) if the TIG welding process has been selected.

### NOTE!

2-step and 4-step welding is only possible if a welding torch with a TIG Multi Connector plug is used.

## Connecting the gas cylinder

### ⚠ WARNING!

#### Danger from falling gas cylinders.

This can result in severe personal injury and damage to property.

- ▶ Place gas cylinders on a solid, level surface so that they remain stable. Secure gas cylinders to prevent them from falling over.
- ▶ Observe the safety rules of the gas cylinder manufacturer.

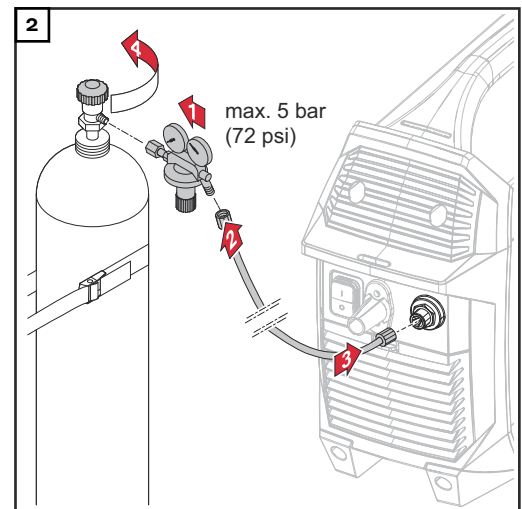
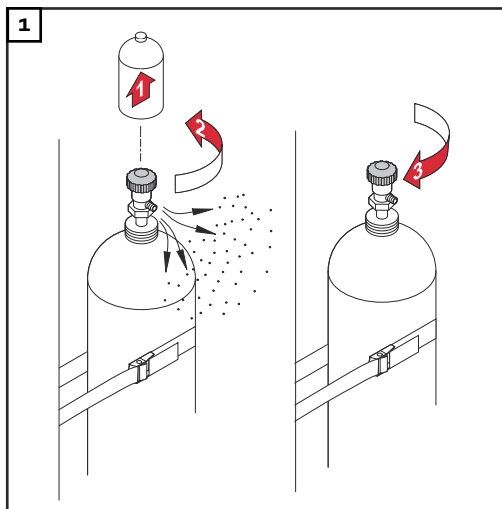

Preparation

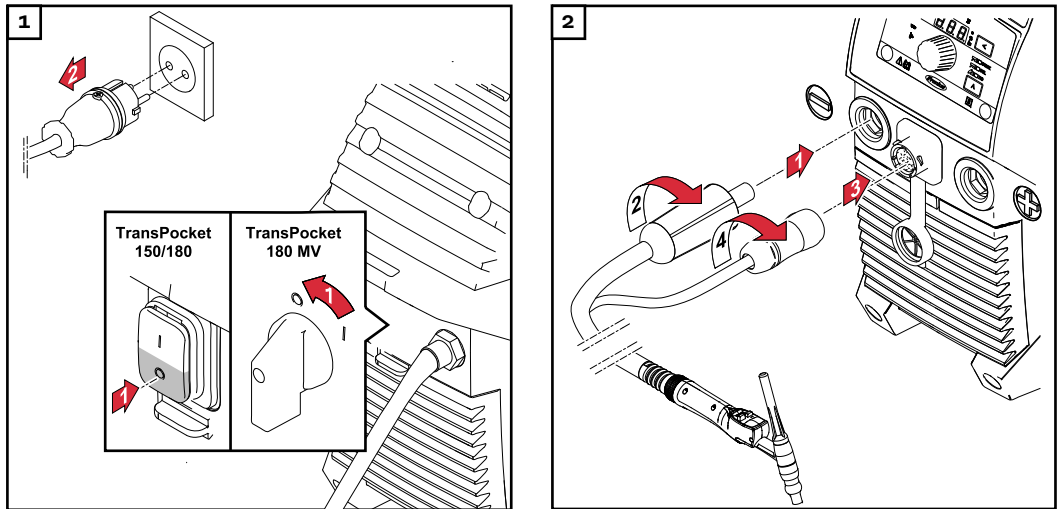

**⚠ CAUTION!**

**Danger from electric shocks. As soon as the power source is switched on, the electrode in the welding torch is live.**

This can result in injury and damage to property.

- Ensure the electrode does not touch any persons or electrically conductive or earthed parts (e.g. the housing, etc.).

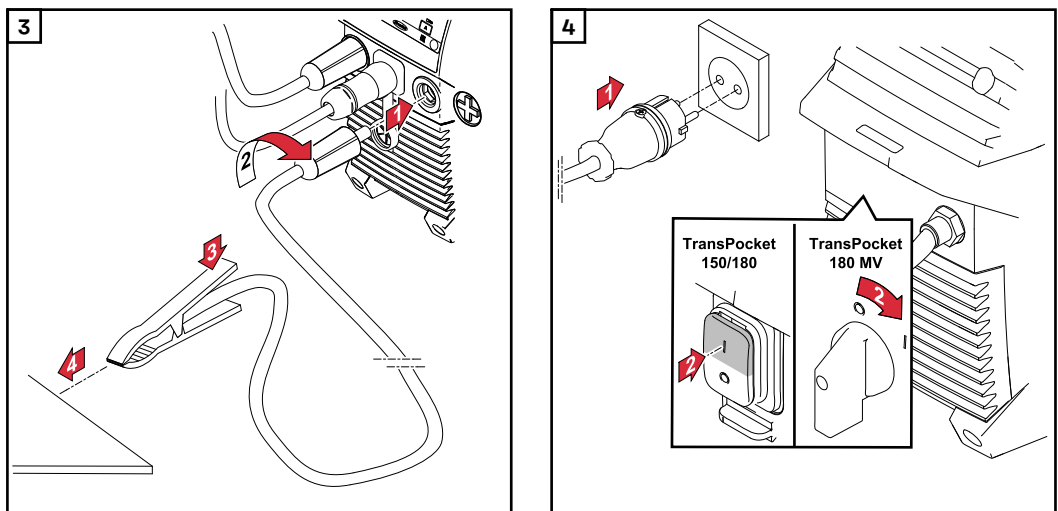

- 5 If a welding torch is used without a TIG Multi Connector plug:  
In the Setup menu for the (trigger mode) "operating mode" parameter, select the OFF setting (2-step or 4-step welding only works when a welding torch with a TIG Multi Connector plug is used)

**Setting the gas pressure**

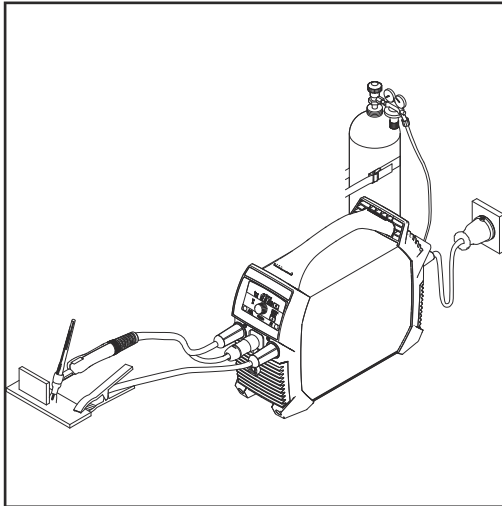





*Welding torch with torch trigger (and TIG Multi Connector plug)*

**Welding torch with torch trigger (and TIG Multi Connector plug):**

- 1** Press the torch trigger  
- shielding gas flows
- 2** Set the desired gas flow rate on the pressure regulator
- 3** Release the torch trigger

**TIG welding**

- |  |   |
|--|---|
| <b>1</b> Select TIG welding with the welding process button  |    |
| - the TIG welding indicator lights up                        |    |
| <b>2</b> Press the setting value button until                |   |
| - the welding current indicator lights up                    |  |
| <b>3</b> Adjust the welding current using the adjusting dial |  |

**When using a welding torch with a torch trigger and TIG Multi Connector plug (with 2-step mode factory setting):**

- 4** Place the gas nozzle down on the ignition location, ensuring there is a gap of approx. 2 to 3 mm (5/64 to 1/8 in.) between the tungsten electrode and the workpiece
- 5** Gradually tilt the welding torch up until the tungsten electrode touches the workpiece
- 6** Pull back and hold the torch trigger  
- shielding gas flows
- 7** Raise the welding torch and rotate it into its normal position  
- the arc ignites
- 8** Carry out welding

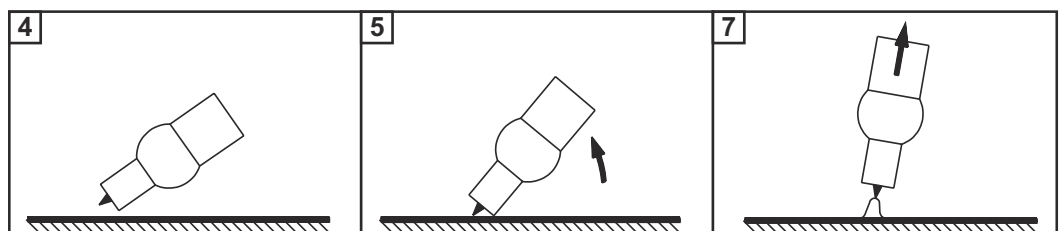

**TIG Comfort Stop**

To activate and set the TIG Comfort Stop function, see the description **Comfort Stop Sensitivity** starting on page 44.

**Operating principle and use of the TIG Comfort Stop:**

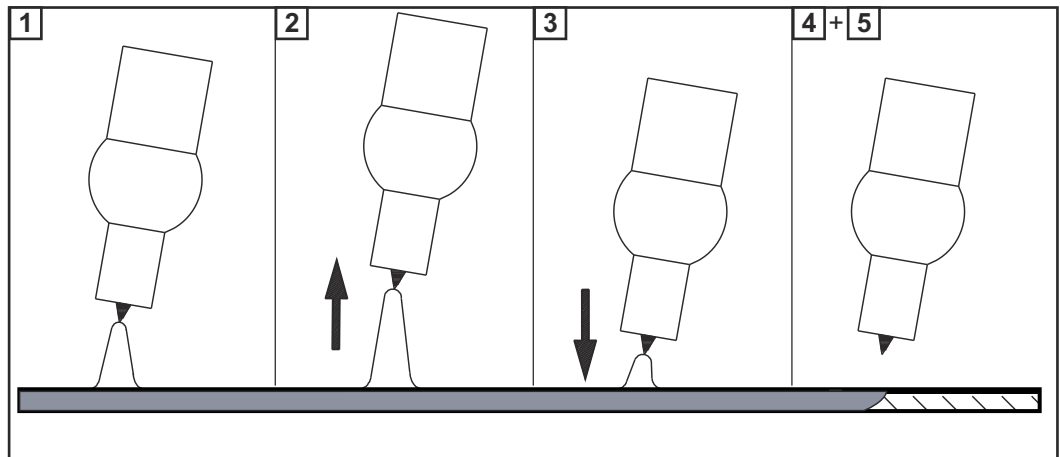

- 1** Welding
- 2** During welding, raise the welding torch
  - the arc length is increased significantly
- 3** Lower the torch
  - the arc length is decreased significantly
  - the TIG Comfort Stop function is activated
- 4** Keep the welding torch at the same height
  - the welding current continually decreases (DownSlope) until the arc goes out
- 5** Wait for the gas post-flow time to finish and lift the welding torch away from the workpiece

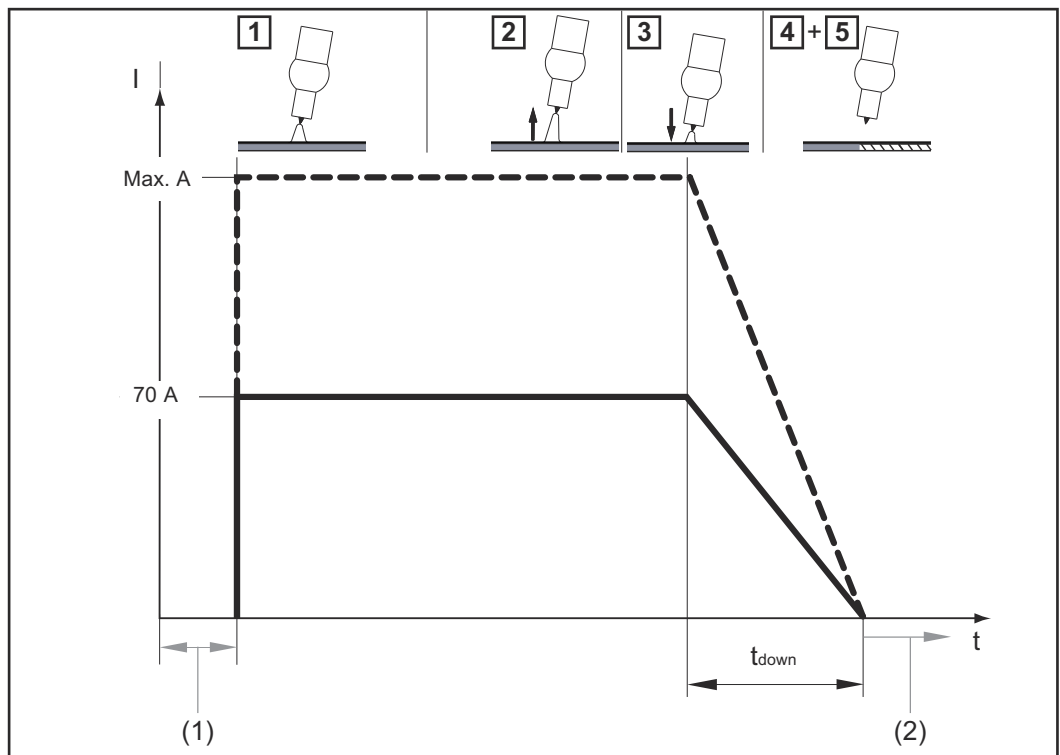

*Welding current and gas flow curve with TIG Comfort Stop function activated*

- (1) Gas pre-flow
- (2) Gas post-flow

**DownSlope:**

The DownSlope time  $t_{down}$  is 0.5 seconds and cannot be adjusted.

**Gas post-flow:**

The gas post-flow can be changed in the Setup menu via the "Gas post-flow time" parameter (Gas Post flow).

**Pulse welding**

Pulse welding is welding with a pulsing welding current. It is used for out-of-position welding of steel pipes or when welding thin sheets.

In these applications, the welding current set at the start of welding is not always ideal for the whole welding process:

- if the amperage is too low, the base material will not melt sufficiently
- if overheating occurs, the liquid weld pool may drip

**Setting range:** 0.5 - 100 Hz

**Operating principle:**

- A low base current I-G rises steeply to the significantly higher pulse current I-P and drops back to the base current I-G after the Duty cycle dcY time.
- The pulse current I-P can be set on the power source.
- This results in an average current that is lower than the set pulse current I-P.
- During pulse welding, small sections of the welding location melt quickly and then rapidly re-solidify.

The power source controls the Duty cycle dcY parameter and base current I-G according to the set pulse current and pulse frequency.

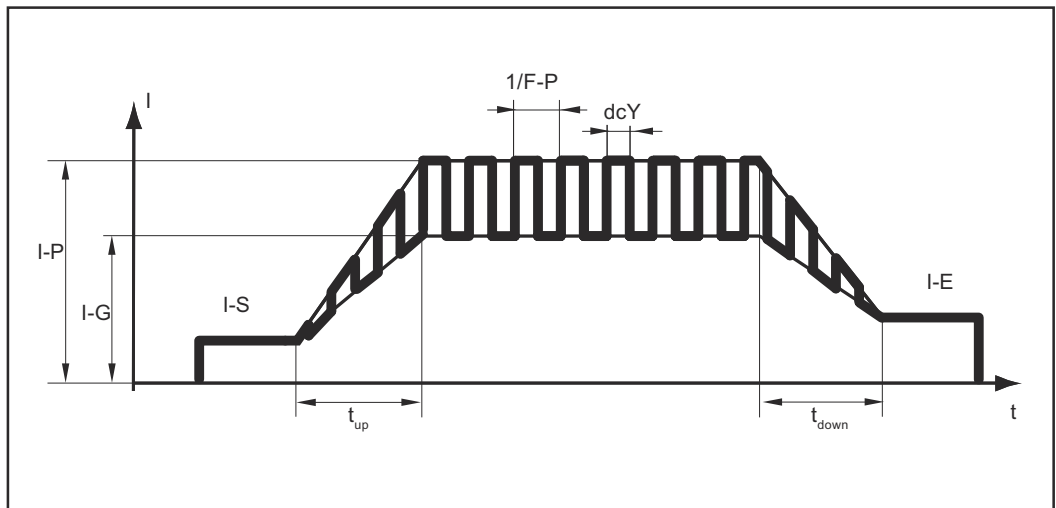

*Pulse welding - welding current curve*

**Adjustable parameters:**

- I-S = starting current
- I-E = final current
- F-P = pulse frequency ( $1/F-P$  = time interval between two pulses)
- I-P = pulse current

**Fixed parameters:**

- $t_{up}$  = UpSlope
- $t_{Down}$  = DownSlope
- dcY = duty cycle
- I-G = base current

**To use pulse welding:**

**1** Press the setting value button until



- the pulse welding indicator lights up



**2** Turn the adjusting dial until the desired frequency value (Hz) is reached



- power source is ready for welding

**Tacking function**

To activate and set the tacking function, see the description **Tacking function (tACKing)** starting on page 44.

- When a time period is specified for the tAC (tacking) setup parameter, the tacking function is assigned to all operating modes
- The basic operating sequence of each of these modes remains unchanged
- During the specified period, welding occurs with a pulse current that makes the weld pool run together better when two components are being tacked.

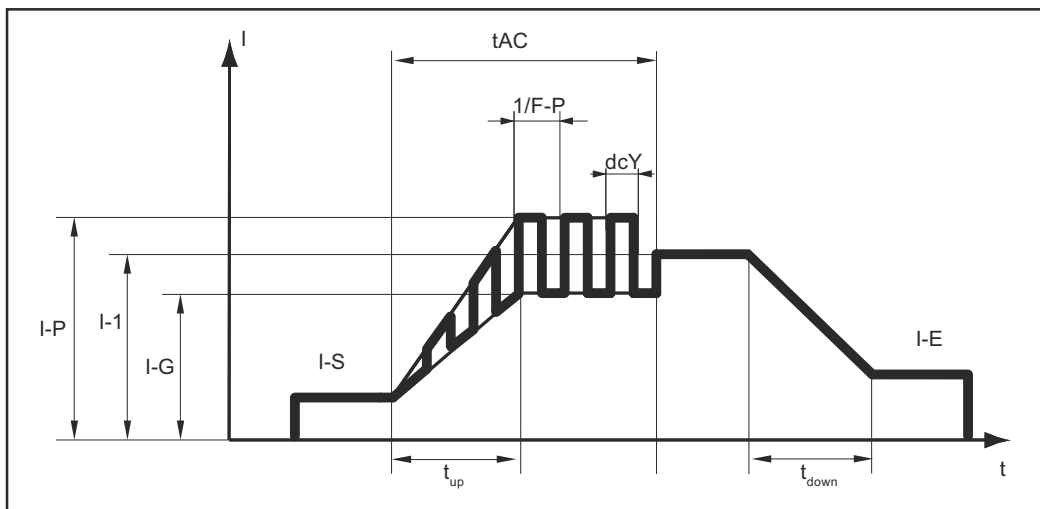

Welding current curve

**Adjustable parameters:**

- tAC = duration of the pulse current for the tacking process
- I-E = final current
- I-S = starting current
- I-1 = main flow

**Fixed parameters:**

- $t_{up}$  = UpSlope
- $t_{Down}$  = DownSlope
- I-P = pulse current
- dcY = duty cycle
- F-P = pulse frequency
- I-G = base current

The power source controls the pulse frequency F-P, pulse current I-P, duty cycle dcY and base current I-G parameters according to the set main current I-1.

The pulse current starts







- after the end of the starting-current phase I-S
- with the UpSlope phase  $t_{up}$

After the tAC time has elapsed, welding continues at a constant welding current, and any pulse parameters that may have been set are available.







# Welding process Setup menu



## Accessing the Setup menu

1	Use the Welding Process button to select the process whose Setup parameters are to be changed:	
	- MMA welding	
	- MMA welding with Cel electrode	
	- TIG welding	
2	Press the Setting Value and Welding Process buttons at the same time	
	- The code for the first parameter in the Setup menu is displayed on the control panel	

## Changing welding parameters

1	Turn the adjusting dial to select the required parameter	
2	Press the adjusting dial to display the preset value of the parameter	
3	Turn the adjusting dial to change the value	
	- the new value becomes effective immediately - exception: when restoring the factory settings, press the adjusting dial after changing the value to activate the new value.	
4	Press the adjusting dial to return to the list of parameters	

## Exiting the Setup menu

1	Press the Setting Value <b>or</b> Welding Process button to exit the Setup menu	
		

## Parameters for MMA welding

Parameter	Description	Range	Unit
	<b>Starting current duration</b> For the SoftStart / HotStart function Factory setting: 0.5 seconds	0.1 - 2.0	Second s

Parameter	Description	Range	Unit
<b>AST</b>	<p><b>Anti-stick</b></p> <p>When the anti-stick function is active, the arc is extinguished after 1.5 seconds in the event of a short circuit (sticking of the electrode)</p> <p>Factory setting: ON (activated)</p>		On OFF
<b>Str</b>	<p><b>Start ramp</b></p> <p>To activate/deactivate grinding mode</p> <p>Factory setting: ON (activated)</p>		On OFF
<b>Uco</b>	<p><b>Break voltage (Voltage cut off)</b></p> <p>Used to specify at which arc length the welding process is to be completed. The welding voltage increases as the length of the arc increases. The arc is extinguished when it reaches the voltage specified here</p> <p>Factory setting: 45 volts</p>	25 - 90	Volts
<b>FAC</b>	<p><b>Factory setting (FACTory)</b></p> <p>This can be used to reset the device to its factory settings</p> <ul style="list-style-type: none"> <li>- cancel reset</li> <li>- reset the parameters for the selected welding process to their factory settings</li> <li>- reset the parameters for all welding processes to their factory settings</li> </ul>		no YES ALL
 <p>Resetting of the selected value to its factory setting must be confirmed by pressing the adjusting dial.</p>			
<b>2nd</b>	<p><b>Level 2 Setup menu</b></p> <p>To set general welding parameters</p> <p>For details, see the "Level 2 Setup menu" section</p>		

Parameters for  
TIG welding

Parameter	Description	Range	Unit
<b>tri</b>	<b>Operating mode (trigger mode)</b>		
	- Operation using welding torch without a torch trigger	OFF	
	- 2-step mode	2t	
	- 4-step mode	4t	
	Factory setting: 2t		
<b>1-5</b>	<b>Starting current (I-Start)</b>	1 - 200	Percent
	This parameter is only available in 4-step mode ( <b>tri</b> = 4t)		
	Factory setting: 35%		
<b>1-2</b>	<b>Reduced current</b>	1 - 200	Percent
	This parameter is only available in 4-step mode ( <b>tri</b> = 4t)		
	Factory setting: 50%		
<b>1-E</b>	<b>Final current (I-End)</b>	1 - 100	Percent
	This parameter is only available in 4-step mode ( <b>tri</b> = 4t)		
	Factory setting: 30%		
<b>GPf</b>	<b>Gas pre-flow time (Gas Pre flow)</b>	0.0 - 9.9	Second s
	Duration of gas pre-flow		
	Factory setting: 0.0 seconds		
<b>GPo</b>	<b>Gas post-flow (Gas Post flow)</b>	AUt 0.2 - 25	Second s
	Specified period during which gas flows at the end of welding		
	Factory setting: AUt		
<b>GPU</b>	<b>Gas purging (gas purging)</b>	0.1 - 9.9	Minutes
	Purging of the protective gas shield begins as soon as GPU is allocated a value. For safety reasons, purging of the protective gas shield cannot be restarted until a new GPU value is entered.		
	<b>IMPORTANT!</b> Purging the shielding gas is necessary if condensation forms when the device is left unused in a cold environment for a prolonged period. Long hosepacks are most affected.		
	Factory setting: off		

Parameter	Description	Range	Unit
<b>C55</b>	<p><b>Comfort Stop Sensitivity</b></p> <p>This parameter is only available when the <b>tri</b> parameter is set to OFF</p> <p>Factory setting: 1.5 V</p> <p>For details, see <b>TIG Comfort Stop</b> starting at page <b>37</b></p>	0.6 - 3.5	Volts
<b>Uco</b>	<p><b>Break voltage (Voltage cut off)</b></p> <p>Used to specify at which arc length the welding process is to be completed. The welding voltage increases as the length of the arc increases. The arc is extinguished when it reaches the voltage specified here.</p> <p>Factory setting: 35 volts (for 2-step mode, 4-step mode and pedal remote control)</p> <p>Factory setting: 25 V (for the trigger = OFF mode)</p>	10 - 45	Volts
<b>tAC</b>	<p><b>Tacking function (tACking)</b></p> <p>Factory setting: OFF</p> <p>For details, see description of the "Tacking function"</p>	<p>OFF</p> <p>0.1 - 9.9</p>	Seconds
<b>FAC</b>	<p><b>Factory setting (FACTory)</b></p> <p>This can be used to reset the device to its factory settings</p> <ul style="list-style-type: none"> <li>- cancel reset</li> <li>- reset the parameters for the selected welding process to their factory settings</li> <li>- reset the parameters for all welding processes to their factory settings</li> </ul> <div style="background-color: #0000FF; color: white; padding: 5px;">  <p>Resetting of the selected value to its factory setting must be confirmed by pressing the adjusting dial.</p> </div>	<p>no</p> <p>YES</p> <p>ALL</p>	
<b>2nd</b>	<p><b>Level 2 Setup menu</b></p> <p>To set general welding parameters</p> <p>For details, see the "Level 2 Setup menu" chapter</p>		

# Setup menu - Level 2

Welding parameters in the level 2 Setup menu

Parameter	Description	Range	Unit
<b>50F</b>	<p><b>Software version</b></p> <p>The full version number of the currently installed software is spread across a number of displays and can be retrieved by turning the adjusting dial</p>		
<b>t5d</b>	<p><b>Automatic switch-off (time Shut down)</b></p> <p>If the device is not used or operated for a specified period of time, it automatically switches itself into Standby mode</p> <p>Pressing any button on the control panel will cancel Standby mode and the device will be ready to resume welding</p> <p>Factory setting: OFF</p>	5 - 60 OFF	Minutes
<b>FUS</b>	<p><b>Fuse</b></p> <p>For displaying/setting the fuse used</p> <p>Factory setting:</p> <ul style="list-style-type: none"> <li>- for mains voltage 230 V = 16 A</li> <li>- for mains voltage 120 V = 20 A</li> </ul> <p>If a fuse is set on the power source, the power source limits the power drawn from the mains. This prevents the circuit breaker from tripping immediately</p>	At 230 V: 10 / 13 / 16 / OFF (TP 180 MV only)	Ampere
		At 120 V: 15 / 16 / 20 / OFF (TP 180 MV only)	

TransPocket 150 - Ratio between set fuse and welding current:				
Mains voltage	Set fuse	Welding current electrode	TIG welding current	Duty cycle
230 V	10 A	110 A	150 A	35 %
	13 A	130 A	150 A	35 %
	16 A	150 A	150 A	35 %

TransPocket 180 - Ratio between set fuse and welding current:				
Mains voltage	Set fuse	Welding current electrode	TIG welding current	Duty cycle
230 V	10 A	125 A	180 A	40 %
	13 A	150 A	200 A	40 %
	16 A	180 A	220 A	40 %

	OFF (TP 180 MV only)	180 A	220 A	40 %
120 V*	15 A	85 A	130 A	40 %
	16 A	95 A	140 A	40 %
	20 A (TP 180 MV only)	120 A	170 A	40 %
	OFF (TP 180 MV only)	120 A	170 A	40 %

\* Depending on the triggering characteristic of the circuit breaker, the full duty cycle of 40% cannot be achieved on 120 V grids (e.g. USA circuit breaker type CH-15% D.C.).

Parameter	Description	Range	Unit
<b>5ot</b>	<p><b>Operating time (System on time)</b></p> <p>For displaying the operating time (begins to count as soon as the device is switched on)</p> <p>The full operating time is spread across a number of displays and can be retrieved by turning the adjusting dial</p>		Hours, minutes, seconds
<b>5At</b>	<p><b>Welding time (System Active time)</b></p> <p>For displaying how long the system has been active for (only shows the time during which welding was in progress)</p> <p>The full system active time is spread across a number of displays and can be retrieved by turning the adjusting dial</p>		Hours, minutes, seconds

# Care, maintenance and disposal

## Safety

### **WARNING!**

#### **Danger from incorrect operation and work that is not carried out properly.**

This can result in serious personal injury and damage to property.

- ▶ All the work and functions described in this document must only be carried out by technically trained and qualified personnel.
- ▶ Read and understand this document in full.
- ▶ Read and understand all safety rules and user documentation for this device and all system components.

### **WARNING!**

#### **Danger from electrical current.**

This can result in serious personal injury and damage to property.

- ▶ Before starting work, switch off all devices and components involved and disconnect them from the grid.
- ▶ Secure all devices and components involved so they cannot be switched back on.
- ▶ After opening the device, use a suitable measuring instrument to check that electrically charged components (such as capacitors) have been discharged.

### **WARNING!**

#### **Danger due to insufficient ground conductor connection.**

This can result in serious personal injury and damage to property.

- ▶ The housing screws provide a suitable ground conductor connection for grounding the housing.
- ▶ The housing screws must not under any circumstances be replaced by other screws without a reliable ground conductor connection.

## General

Under normal operating conditions, the device requires only a minimum of care and maintenance. However, it is vital to observe some important points to ensure the device remains in a usable condition for many years.

## Maintenance at every start-up

- Ensure that the mains plug and mains cable as well as the welding torch / electrode holder are undamaged. Replace any damaged components
- Ensure that the welding torch / electrode holder and the grounding cable are properly connected to the power source and screwed/locked in place as described in this document
- Ensure that a proper ground earth connection has been established to the workpiece
- Check that there is an all-round clearance of 0.5 m (1 ft. 8 in.) around the device to ensure that cooling air can flow and escape unhindered. Air inlets and outlets must never be covered, not even partially.

---

**Maintenance  
every 2 months**

Clean air filter:

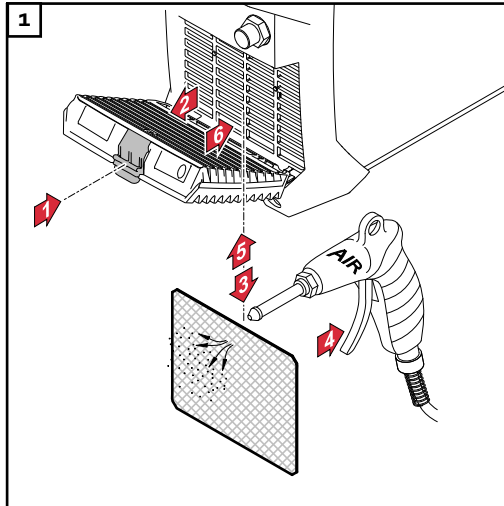

---

**Disposal**

Dispose of in accordance with the applicable national and local regulations.



## Safety

### **WARNING!**

#### **Danger from incorrect operation and work that is not carried out properly.**

This can result in serious personal injury and damage to property.

- ▶ All the work and functions described in this document must only be carried out by technically trained and qualified personnel.
- ▶ Read and understand this document in full.
- ▶ Read and understand all safety rules and user documentation for this device and all system components.

### **WARNING!**

#### **Danger from electrical current.**

This can result in serious personal injury and damage to property.

- ▶ Before starting work, switch off all devices and components involved and disconnect them from the grid.
- ▶ Secure all devices and components involved so they cannot be switched back on.
- ▶ After opening the device, use a suitable measuring instrument to check that electrically charged components (such as capacitors) have been discharged.

### **WARNING!**

#### **Danger due to insufficient ground conductor connection.**

This can result in serious personal injury and damage to property.

- ▶ The housing screws provide a suitable ground conductor connection for grounding the housing.
- ▶ The housing screws must not under any circumstances be replaced by other screws without a reliable ground conductor connection.

## Indicated errors

### **Overtemperature**

"hot" appears on the display, the temperature indicator lights up



Cause: Operating temperature too high

Remedy: Allow device to cool (do not switch off the device - the fan will cool it down)

## Service messages

When E and a 2 digit error number appear in the display (e.g. E02) and the "Error" indicator lights up, this is an internal power source service code.

### **Example:**



It is also possible that several error numbers are present. These appear when turning the adjusting dial.



Make a note of the error numbers shown in the display, and of the serial number and configuration of the power source, and contact our after-sales service team with a detailed description of the error.

---

**E01 - E03 / E11 / E15 / E21 / E33 - E35 / E37 - E40 / E42 - E44 / E46 - E52**

Cause: Fault in power module  
Remedy: Contact After-Sales Service

---

**E04**

Cause: Open circuit voltage is not being reached:  
electrode in contact with workpiece / hardware fault  
Remedy: Remove electrode holder from workpiece. If the service code continues to be displayed, contact after-sales service

---

**E05 / E06 / E12**

Cause: System start-up failed  
Remedy: Switch device off and on again. Contact after-sales service if a repeated occurrence

---

**E10**

Cause: Overvoltage at the current socket ( $> 113 V_{DC}$ )  
Remedy: Contact after-sales service

---

**E16 / E17**

Cause: Memory fault  
Remedy: Contact After-Sales Service / Press adjusting dial to acknowledge the service message

---

**NOTE!**

**On standard variants of the device, acknowledging the service message has no effect on the availability of power source functions.**

On all other variants (TIG, etc.), only a restricted range of functions is available after acknowledging the message. Contact After-Sales Service to have the full functionality restored.

---

**E19**

Cause: Overtemperature or undertemperature  
Remedy: Operate the device in permitted ambient temperatures. For more details on environmental conditions, see "Environmental conditions" in the "Safety rules" section

---

**E20**

Cause: Improper use of the device  
Remedy: Only use the device for its intended purpose

---

**E22**

Cause: Welding current set too high  
Remedy: Ensure that the power source is being operated on the correct mains voltage; ensure that the correct fuse is set; set a lower welding current

---

---

**E37**

Cause: Mains voltage too high

Remedy: Pull out the mains plug immediately; ensure that the power source is being operated on the correct mains voltage

---

**E36, E41, E45**

Cause: Mains voltage outside tolerance or maximum load of grid is too low

Remedy: Ensure that the power source is being operated on the correct mains voltage; ensure that the correct fuse is set;

---

**E65 - E75**

Cause: Communication error with the display

Remedy: Switch device off and on again / contact after-sales service if a repeated occurrence

---

---

**No function**

---

**The device cannot be switched on**

Cause: Mains switch is faulty

Remedy: Contact After-Sales Service

---

**No welding current**

Power source is switched on, indicator for the selected welding process is lit

Cause: Welding power-lead connections have been disconnected

Remedy: Establish proper welding power-lead connections

Cause: Poor or no earth

Remedy: Establish a connection to the workpiece

Cause: There is a break in the power cable in the welding torch or electrode holder

Remedy: Replace welding torch or electrode holder

---

**No welding current**

Device switched on, indicator for the selected welding process is lit, overtemperature indicator lit

Cause: Duty cycle exceeded - device overloaded - fan running

Remedy: Keep within duty cycle

Cause: Thermostatic automatic circuit breaker has switched off the device

Remedy: Wait until the power source comes back on automatically at the end of the cooling phase (do not switch off the device - the fan will cool it down)

Cause: The fan in the power source is faulty

Remedy: Contact After-Sales Service

Cause: Insufficient cooling air intake

Remedy: Ensure adequate air supply

Cause: Air filter is dirty

Remedy: Clean air filter

Cause: Power module error

Remedy: Turn off the device, then turn it on again

If the error occurs frequently, contact After-Sales Service

---

---

**Faulty operation**

---

**Poor ignition properties during MMA welding**

Cause: Incorrect welding process selected

Remedy: Select "MMA welding" or "MMA welding with Cel electrode" process

Cause: Starting current too low; electrode sticking during ignition

Remedy: Increase starting current using HotStart function

Cause: Starting current too high; electrode consumed too quickly during ignition or is generating a lot of spatter

Remedy: Reduce starting current using SoftStart function

---

**In some cases, arc breaks during welding**

Cause: Break voltage (Uco) set too low

Remedy: Increase break voltage (Uco) in Setup menu

Cause: Electrode (e.g. grooved electrode) voltage too high

Remedy: If possible, use an alternative electrode or a power source with more welding power

---

**Rod electrode tends to stick**

Cause: Value of arc-force dynamic parameter (MMA welding) set too low

Remedy: Increase value of arc-force dynamic parameter

---

---

**Poor weld properties**

(severe spattering)

Cause: Incorrect electrode polarity

Remedy: Reverse electrode polarity (refer to manufacturer's instructions)

Cause: Poor grounding (earthing) connection

Remedy: Fasten earthing clamps directly to workpiece

Cause: Setup parameters not ideal for selected welding process

Remedy: Select the optimal settings in the Setup menu for the selected welding process

---

**Tungsten electrode melting**

Tungsten inclusions in base metal during the ignition phase

Cause: Incorrect tungsten electrode polarity

Remedy: Connect the TIG welding torch to the (-) current socket

Cause: Incorrect (or no) shielding gas

Remedy: Use inert shielding gas (argon)

---

# Average consumption values during welding

## Average wire electrode consumption during MIG/MAG welding

Average wire electrode consumption at a wire speed of 5 m/min			
	1.0 mm wire electrode diameter	1.2 mm wire electrode diameter	1.6 mm wire electrode diameter
Steel wire electrode	1.8 kg/h	2.7 kg/h	4.7 kg/h
Aluminium wire electrode	0.6 kg/h	0.9 kg/h	1.6 kg/h
CrNi wire electrode	1.9 kg/h	2.8 kg/h	4.8 kg/h

Average wire electrode consumption at a wire speed of 10 m/min			
	1.0 mm wire electrode diameter	1.2 mm wire electrode diameter	1.6 mm wire electrode diameter
Steel wire electrode	3.7 kg/h	5.3 kg/h	9.5 kg/h
Aluminium wire electrode	1.3 kg/h	1.8 kg/h	3.2 kg/h
CrNi wire electrode	3.8 kg/h	5.4 kg/h	9.6 kg/h

## Average shielding gas consumption during MIG/MAG welding

Wire electrode diameter	1.0 mm	1.2 mm	1.6 mm	2.0 mm	2 x 1.2 mm (TWIN)
Average consumption	10 l/min	12 l/min	16 l/min	20 l/min	24 l/min

## Average shielding gas consumption during TIG welding

Gas nozzle size	4	5	6	7	8	10
Average consumption	6 l/min	8 l/min	10 l/min	12 l/min	12 l/min	15 l/min

# Technical data

## Explanation of the term "duty cycle"

Duty cycle (ED) is the proportion of time in a 10-minute cycle at which the device may be operated at its rated output without overheating.

**NOTE!**

The ED values specified on the rating plate are based on an ambient temperature of 40 °C.

If the ambient temperature is higher, either the ED or output must be reduced accordingly.

Example: Welding at 150 A at 60% ED

- Welding phase = 60% of 10 minutes = 6 minutes
- Cooling phase = remaining time = 4 minutes
- After the cooling phase, the cycle begins again.

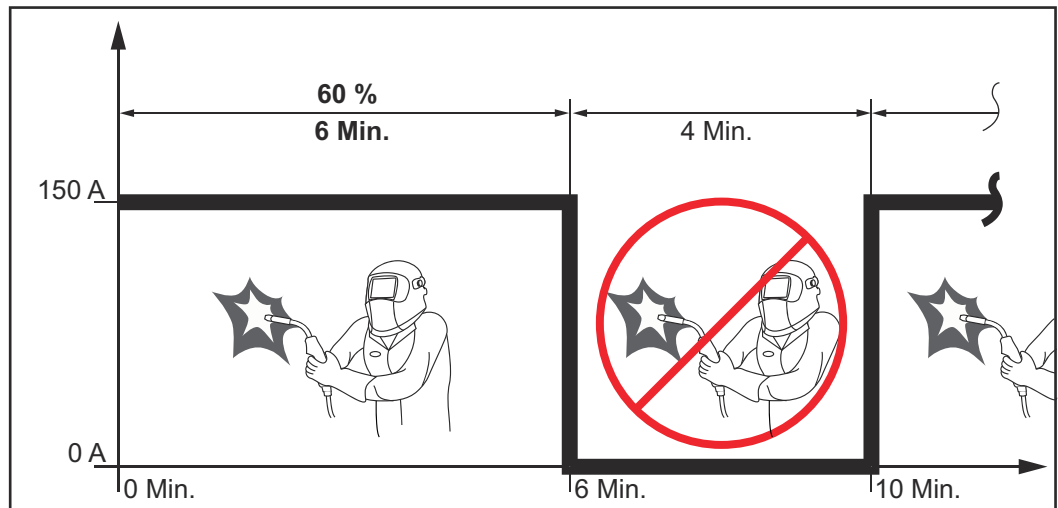

If the device is to be continuously operated without stopping:

- 1 Look in the technical data for a ED value of 100% for the current ambient temperature.
- 2 Reduce the output or amperage in line with this value so that the device can remain in use without observing a cooling phase.

## TransPocket 150 TIG

Mains voltage ( $U_1$ )	1 x 230 V
Max. effective primary current ( $I_{1eff}$ )	15 A
Max. primary current ( $I_{1max}$ )	24 A
Max. apparent power ( $S_{1max}$ )	5.52 kVA
Mains fuse protection	16 A slow-blow
Mains voltage tolerance	-20% / +15%
Grid frequency	50/60 Hz

Cos phi	0.99		
Max. permitted mains impedance $Z_{\max}$ at PCC <sup>1)</sup>	32 mOhm		
Recommended earth-leakage circuit breaker	Type B		
Welding current range ( $I_2$ ) rod electrode	10 - 150 A		
Welding current range ( $I_2$ ) TIG	10 - 150 A		
Welding current for MMA welding 10 min / 40 °C (104 °F)	35 % 150 A	60 % 110 A	100 % 90 A
Welding current for TIG welding 10 min / 40 °C (104 °F)	35 % 150 A	60 % 110 A	100 % 90 A
Output voltage range according to standard characteristic ( $U_2$ ) rod electrode	20.4 - 26 V		
Output voltage range according to standard characteristic ( $U_2$ ) TIG	10.4 - 16 V		
Open circuit voltage ( $U_0$ peak)	96 V		
Degree of protection	IP 23		
Type of cooling	AF		
Overvoltage category	III		
Pollution degree according to IEC60664	3		
EMC device class	A		
Safety symbols	S, CE		
Max. shielding gas pressure	5 bar 72.52 psi		
Dimensions (length x width x height)	365 x 130 x 285 mm 14.4 x 5.1 x 11.2 in.		
Weight	6.6 kg 14.6 lb.		
Idle state power consumption at 230 V	15 W		
Power source efficiency at 150 A / 26 V	87 %		

1) Interface to a 230/400 V and 50 Hz public grid

### TransPocket 180 TIG

Mains voltage ( $U_1$ )	1 x 230 V
Max. effective primary current ( $I_{1\text{eff}}$ )	16 A
Max. primary current ( $I_{1\text{max}}$ )	25 A
Max. apparent power ( $S_{1\text{max}}$ )	5.75 kVA
Mains fuse protection	16 A slow-blow



Mains voltage tolerance	-20% / +15%		
Grid frequency	50/60 Hz		
Cos phi	0.99		
Max. permitted mains impedance $Z_{max}$ at PCC <sup>1)</sup>	285 mOhm		
Recommended earth-leakage circuit breaker	Type B		
Welding current range ( $I_2$ ) rod electrode	10 - 180 A		
Welding current range ( $I_2$ ) TIG	10 - 220 A		
Welding current for MMA welding 10 min / 40 °C (104 °F)	40 % 180 A	60 % 150 A	100 % 120 A
Welding current for TIG welding 10 min / 40 °C (104 °F)	40 % 220 A	60 % 150 A	100 % 120 A
Output voltage range according to standard characteristic ( $U_2$ ) rod electrode	20.4 - 27.2 V		
Output voltage range according to standard characteristic ( $U_2$ ) TIG	10.4 - 18.8 V		
Open circuit voltage ( $U_0$ peak)	101 V		
Degree of protection	IP 23		
Type of cooling	AF		
Overvoltage category	III		
Pollution degree according to IEC60664	3		
EMC device class	A		
Safety symbols	S, CE		
Max. shielding gas pressure	5 bar 72.52 psi		
Dimensions (length x width x height)	435 x 160 x 310 mm 17.1 x 6.3 x 12.2 in.		
Weight	9.0 kg 19.8 lb.		
Idle state power consumption at 230 V	15 W		
Power source efficiency at 180 A / 27.2 V	88 %		

1) Interface to a 230/400 V and 50 Hz public grid

### TransPocket 180 TIG MV

Mains voltage ( $U_1$ )	1 x 230 V	1 x 120 V	1 x 120 V
-------------------------	-----------	-----------	-----------

Max. effective primary current ( $I_{1\text{eff}}$ )	16 A	20 A	15 A
Max. primary current ( $I_{1\text{max}}$ )	25 A	29 A	19 A
Max. apparent power ( $S_{1\text{max}}$ )	5.75 kVA	3.48 kVA	2.28 kVA
Mains fuse protection	16 A slow-blow	20 A slow-blow	15 A slow-blow
Mains voltage tolerance	-20% / +15%		
Grid frequency	50/60 Hz		
Cos phi	0.99		
Max. permitted mains impedance $Z_{\text{max}}$ at PCC <sup>1)</sup>	285 mOhm		
Recommended earth-leakage circuit breaker	Type B		
Welding current range ( $I_2$ )			
rod electrode	10 - 180 A	10 - 120 A	10 - 85 A
TIG	10 - 220 A	10 - 170 A	10 - 140 A
Welding current for MMA welding, 10 min / 40 °C (104 °F)	40%/180 A 60%/150 A 100%/120 A	40%/120 A 60%/100 A 100%/90 A	40%/85 A 60%/70 A 100%/65 A
Welding current for TIG welding, 10 min / 40 °C (104 °F)	40%/220 A 60%/160 A 100%/130 A	40%/170 A 60%/130 A 100%/100 A	40%/140 A 60%/110 A 100%/100 A
Output voltage range according to standard characteristic ( $U_2$ )			
rod electrode	20.4 - 27.2 V		
TIG	10.4 - 18.8 V		
Open circuit voltage ( $U_0$ peak)	101 V		
Degree of protection	IP 23		
Type of cooling	AF		
Oversvoltage category	III		
Pollution degree according to IEC60664	3		
EMC device class	A		
Safety symbols	S, CE		
Max. shielding gas pressure	5 bar 72.52 psi		
Dimensions (length x width x height)	435 x 160 x 310 mm 17.1 x 6.3 x 12.2 in.		
Weight	9.2 kg 20.3 lb.		
Idle state power consumption at 230 V	15 W		
Power source efficiency at 180 A / 27.2 V	88 %		

1) Interface to a 230/400 V and 50 Hz public grid

---

**Overview with critical raw materials, year of production of the device****Overview with critical raw materials:**

An overview of which critical raw materials are contained in this device can be found at the following Internet address.

[www.fronius.com/en/about-fronius/sustainability](http://www.fronius.com/en/about-fronius/sustainability).

**To calculate the year of production of the device:**

- Each device is provided with a serial number
- The serial number consists of 8 digits - for example 28020099
- The first two digits give the number from which the year of production of the device can be calculated
- This figure minus 11 gives the year of production
  - For example: Serial number = **28**020065, calculation of the year of production = **28** - 11 = 17, year of production = 2017



**Fronius International GmbH**

Froniusstraße 1  
4643 Pettenbach  
Austria  
[contact@fronius.com](mailto:contact@fronius.com)  
[www.fronius.com](http://www.fronius.com)

At [www.fronius.com/contact](http://www.fronius.com/contact) you will find the contact details  
of all Fronius subsidiaries and Sales & Service Partners.